

8198 SIP Ceiling Speaker PoE+ with optional 1198 Satellite Speakers

User Guide



Order Codes

8198

SIP Ceiling Speaker PoE+

Table of Contents

Table of Contents	2
Important Safety Information.....	4
Overview.....	7
Introduction.....	7
Setup and Installation.....	9
Getting Started - Quick Install & Test	9
Ceiling Installation	10
Air Handling Spaces UL2043	11
Suspended Installation.....	11
Wiring Connections	11
Connecting Input Devices.....	12
Connecting 1198 satellite speakers (One 8198 with up to three 1198).....	13
Reset	14
Programming and Configuration	14
Features	15
SIP Paging: One 8198 (with or without Satellites).....	15
SIP Ring Event	15
Multicast Overview.....	15
SIP Paging: Multiple Algo SIP Endpoints (Using Multicast).....	16
SIP Paging: Multiple Speakers (Using Individual SIP extensions).....	16
SIP Activated Notification Alerts	16
Background Music Streaming.....	17
Polycom™ Group Paging.....	17
TLS for SIP Signaling and Provisioning	17
Web Interface Status and Login	21
Web Interface Login	21
Status	22
Web Interface Basic Settings	23
Basic Settings Tab – SIP	23
Basic Settings Tab – Features	25
Basic Settings Tab – Multicast	27
Basic Settings Tab – Multicast (Slave Settings)	31
Web Interface Additional Features	33
Additional Features Tab – Input/Output	33
Additional Features Tab – Emergency Alerts	37
Additional Features Tab – More Page Extensions	39
Additional Features Tab – More Ring Extensions.....	40
Web Interface Advanced Settings	41
Advanced Settings Tab – Network.....	41
Advanced Settings Tab – Admin	43

Advanced Settings Tab – Time.....	47
Advanced Settings Tab – Provisioning	48
Advanced Settings Tab – Advanced Audio	50
Advanced Settings Tab – Advanced SIP	52
Advanced Settings Tab – Advanced Multicast	56
Web Interface System	58
System Tab - Maintenance	58
System Tab - Firmware.....	59
System Tab – File Manager	60
System Tab – Tones	61
System Tab – System Log	62
Specifications	63
FCC Compliance Statement.....	64

Important Safety Information

Important Safety Information

This product is powered by a certified limited power source (LPS), Power over Ethernet (PoE); through CAT5 or CAT6 connection wiring to an IEEE 802.3at PoE+ or 802.3af compliant network PoE switch. The product is intended for installation indoors. All wiring connections to the product must be in the same building. If the product is installed beyond the building perimeter or used in an inter-building application, the wiring connections must be protected against overvoltage/transient. Algo recommends that this product is installed by a qualified electrician.

If you are unable to understand the English language safety information then please contact Algo by email for assistance before attempting an installation support@algosolutions.com.

Consignes de Sécurité Importantes

Ce produit est alimenté par une source d'alimentation limitée certifiée (alimentation par Ethernet); des câbles de catégorie 5 et 6 joignent un commutateur réseau à alimentation par Ethernet homologué IEEE 802.3at PoE+ or 802.3af. Le produit est conçu pour être installé à l'intérieur. Tout le câblage rattaché au produit doit se trouver dans le même édifice. Si le produit est installé au-delà du périmètre de l'édifice ou utilisé pour plusieurs édifices, le câblage doit être protégé des surtensions transitoires. Algo recommande qu'un électricien qualifié se charge de l'installation de ce produit.

Si vous ne pouvez comprendre les consignes de sécurité en anglais, veuillez communiquer avec Algo par courriel avant d'entreprendre l'installation au support@algosolutions.com.

Información de Seguridad Importante

Este producto funciona con una fuente de alimentación limitada (Limited Power Source, LPS) certificada, Alimentación a través de Ethernet (Power over Ethernet, PoE); mediante un cable de conexión CAT5 o CAT6 a un conmutador de red con PoE en cumplimiento con IEEE 802.3at PoE+ or 802.3af. El producto se debe instalar en lugares cerrados. Todas las conexiones cableadas al producto deben estar en el mismo edificio. Si el producto se instala fuera del perímetro del edificio o se utiliza en una aplicación en varios edificios, las conexiones cableadas se deben proteger contra sobretensión o corriente transitoria. Algo recomienda que la instalación de este producto la realice un electricista calificado.

Si usted no puede comprender la información de seguridad en inglés, comuníquese con Algo por correo electrónico para obtener asistencia antes de intentar instalarlo: support@algosolutions.com.

Wichtige Sicherheitsinformationen

Dieses Produkt wird durch eine zertifizierte Stromquelle mit begrenzter Leistung (LPS - Limited Power Source) betrieben. Die Stromversorgung erfolgt über Ethernet (PoE - Power over Ethernet). Dies geschieht durch eine Cat-5-Verbindung oder eine Cat-6-Verbindung zu einer IEEE 802.3at PoE+ or 802.3af-konformen Ethernet-Netzwerkweiche. Das Produkt wurde konzipiert für die Installation innerhalb eines Gebäudes. Alle Kabelverbindungen zum Produkt müssen im selben Gebäude bestehen. Wenn das Produkt jenseits des Gebäudes oder für mehrere Gebäude genutzt wird, müssen die Kabelverbindungen vor Überspannung und Spannungssprüngen geschützt werden. Algo empfiehlt das Produkt von einem qualifizierten Elektriker installieren zu lassenv.

Sollten Sie die englischen Sicherheitsinformationen nicht verstehen, kontaktieren Sie bitte Algo per Email bevor Sie mit der Installation beginnen, um Unterstützung zu erhalten. Algo kann unter der folgenden E-Mail-Adresse erreicht werden: support@algosolutions.com.

安全须知

本产品由认证的受限电源 (LPS)，以太网供电 (PoE)，通过 CAT5 或 CAT6 线路联接至 IEEE 802.3at PoE+ or 802.3af 兼容的 PoE 网络交换机供电。本产品适用于室内或建筑物周边安装。所有联接本产品的线路必须源自同一建筑物。本产品如需用于超出建筑物周边范围或跨建筑物的安装，线路联接部分必须有过压和瞬态保护。Algo 建议本产品由专业电工 安装。如果您理解英文版安全须知有问题，安装前请通过电子邮件和 Algo 联系，support@algosolutions.com。

INSTALLATION

An improperly installed 8198 SIP Ceiling Speaker could fall from the ceiling and cause serious injury or death. The four screw mounting clamps will adequately support the speaker if the ceiling material is sufficiently strong. An optional T-bar mounting bracket (Algo 8188TBR) or Ceiling Tile 2'x2' Pane (8188T2x2) is recommended for acoustic ceiling tile and may be required for compliance with local building code. A 1/4-20 threaded insert nut on top of the speaker housing can accept an eye-bolt (not supplied) for chain or cable support and additional safety.

Local building codes may require one or more additional safety measures, particularly in earthquake prone regions.

EMERGENCY COMMUNICATION

If used in an emergency communication application, the 8198 SIP Ceiling Speaker should be routinely tested. SNMP supervision is recommended for assurance of proper operation. Contact Algo for other methods of operational assurance.

DRY INDOOR LOCATION ONLY

The 8198 SIP Ceiling Speaker is intended for dry indoor locations only. For outdoor locations, Algo offers weatherproof speakers and strobe lights.

CAT5 or CAT6 connection wiring to an IEEE 802.3af compliant network PoE switch must not leave the building perimeter without adequate lightning protection.

No wiring connected to the 8198 SIP Ceiling Speaker may leave the building perimeter without adequate lightning protection.

Overview

Introduction

The 8198 SIP Ceiling Speaker is a SIP compliant and multicast capable IP speaker suitable for voice paging, notification, and background music, and ideal for office, retail, healthcare and education environments.

The 8198 SIP Ceiling Speaker allows up to three 1198 Satellite Speakers to be connected, which allows it to cover a large area with only one 8198. This reduces the number of network connections that are required, which can reduce the total cost of installation. The 8198 provides a total of 16W of audio. It can be used independently with up to 16W from the single speaker, or with the power shared equally with the satellites (e.g. 4W to each speaker when using the 8189 with 3 x 1198 satellites).

The 6.5" (165mm) coaxial speaker is G.722 wideband capable and music capable using a fullband codec. An integrated microphone provides talkback capability and ambient noise detection for automatic level control.

Dual SIP extensions provide both voice paging and notification (ring) capability. One or both extensions can be registered with any Communication Server (hosted or enterprise) that supports 3rd party SIP Endpoints. Additional page and ring extensions are also supported, as well as Emergency Alert extensions.

Multiple speakers in a SIP environment require only one speaker to register as a SIP extension. Multicasting capabilities allow the SIP registered speaker to page and simultaneously stream multicast audio to the other speakers. Any number and variety of Algo speakers, paging adapters, and strobes can be configured in a multicast.

The 8198 is configured using central provisioning features or by accessing a web interface using browsers such as Chrome, Firefox, or Edge.

What is Included

- 8198 SIP Ceiling Speaker
- Trim ring
- Speaker grill
- Tool for grill removal and reset
- Protective wiring cover and screws
- Pluggable terminal block for relay input and output
- Getting Started Sheet
- Hole cut-out template
- Screwdriver

What is not Included

- Optional 1198 Satellite Speaker (up to 3 supported per 8198)
- Optional T-bar support bracket (Algo 8188TBR)

- Optional white Ceiling Tile 2'x2' Panel (8188T2x2)
- Optional Hydrophobic Membrane Screen (8188MEM)
- Optional wall switch (Algo 1202, 1203 or 1204)
- Hardware for cable or chain suspension
- This User Guide (www.algosolutions.com/8198/guide)

Setup and Installation

Getting Started - Quick Install & Test



This guide provides important safety information which should be read thoroughly before permanently installing the product.

1. Connect the 8198 SIP Ceiling Speaker to a PoE or PoE+ network switch. The blue LED on the front will remain on until boot up is completed – about 30 seconds.
2. After the blue LED turn off, press the reset button on the front of the unit to hear the IP address over the speaker. The IP address may also be discovered by downloading the Algo locator tool to find Algo devices on your network:
<http://www.algosolutions.com/locator>
3. Mount the speaker. Instructions are provided in the next section of this sheet.
4. Access the 8198 SIP Ceiling Speaker web page by entering the IP address into a browser (e.g. Chrome, Firefox or Edge) and login using the default password ***algo***.
5. Enter the IP address or the domain name for the SIP server into the SIP Domain field under the **BASIC SETTINGS > SIP** tab.
6. Enter the credentials (SIP Extension, Authentication ID, and Password) for the Page and/or Ring extension. Leave the credentials blank for either extension if there is no intended use to have both registered.

Note: The Authentication ID may also be called Username for some SIP servers, and in some cases may be the same as the SIP extension.
7. Verify the extension is properly registered with the SIP server in the Status tab. Ensure the SIP Registration is “Successful”.
8. Make a call to the speaker by dialing the page SIP extension of the 8198 from a telephone. The speaker should auto-answer, play the default pre-announce audio file, and open a speech path.
9. Carefully install the protective grill, working around the grill until fully installed and flush with the housing.

Ceiling Installation

The 8198 SIP Ceiling Speaker is intended to be mounted in a T-bar acoustic tile, gypsum ceiling, or suspended from a ceiling or truss. The speaker can be secured to the ceiling tile by itself, however, for additional support the speaker may also be tethered using a chain or cable via a 1/4" eye bolt screwed into the speaker (see section – Suspended Installation below).

For more secure installations, optional T-Bar support bracket (8188TBR) **or** Ceiling Tile 2'x2' Panel (8188T2x2) are available that can transfer the speaker weight onto the T-bar rails. Installation instructions are provided with the support bracket.

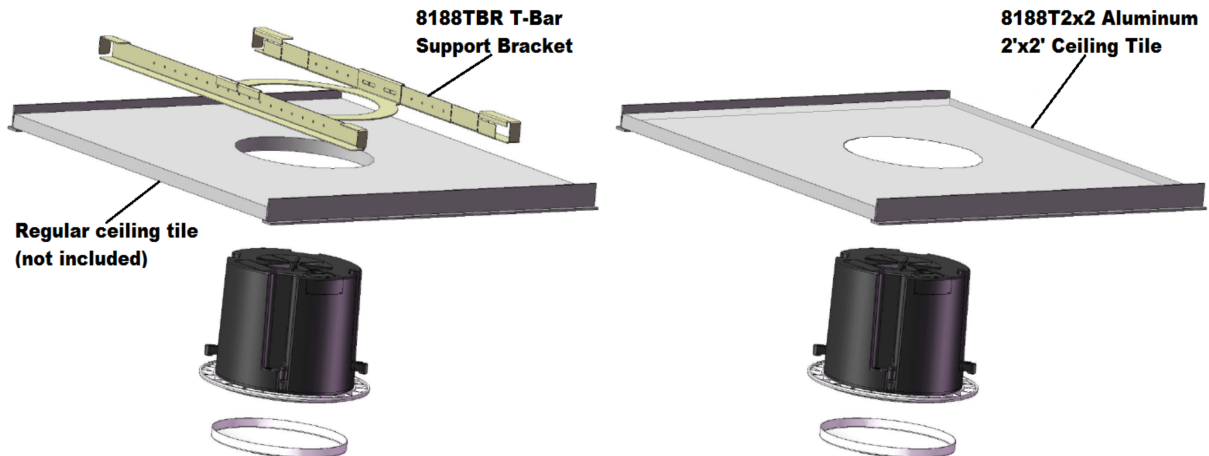

The speaker is shipped with the metal protective grill removed for convenience. This provides access to the four 2" Phillips head screws that operate the four clamps. The clamp screws must be sufficiently loose to allow clamps to rotate and clear the ceiling material thickness of 1 1/4" (3.18 cm) or less. When tightened, the clamps are locked to prevent rotating. Removal of the speaker from the ceiling requires the clamps to be sufficiently loosened before they can rotate in to pass through the 8" (20.5cm) hole.

The removable trim ring must be snapped into location flush with the front surface of the speaker. Lay the trim ring on a flat surface with the ribs facing down and place the speaker in the middle with the speaker facing up. Align the four tabs with the cavities on the speaker housing and slide the trim ring up to the speaker housing until it snaps into place flush with the top.

An 8" (20.5 cm) round hole is required in the ceiling tile. The wiring connections are easiest to make prior to mounting if possible.

Network connection is made by inserting a RJ45 plug into the jack on top of the housing. Wire connections for relay input and output (if used) are made using the 4 position pluggable terminal block provided.

The protective wiring cover may be attached after connections are made. The cover helps prevent any water drips from HVAC or roof leaks from entering the enclosure, as well as keeping dust out of the connections. The cover also provides additional strain relief for the wiring.

With connections made, lift the housing into the ceiling and tighten the 4 clamps using a #2 Phillips screwdriver until snug.



Do NOT over-tighten the clamps. If the clamp screws are over-tightened after the trim ring is snug, the trim ring may detach from the housing requiring the speaker to be removed from the ceiling and the trim ring re-attached.

After installation and testing, gently work the speaker grill into its friction fit position and ensure it is evenly flush to the housing around the edge. The speaker grill is intentionally tight to prevent falling from the ceiling.

A tool supplied with the 8198 SIP Ceiling Speaker can be used to remove the grill. If lost, a small Allen key or heavy duty paperclip bent into an L shape can be used to remove the grill by pulling close to the edge.

Air Handling Spaces UL2043

The 8198 SIP Ceiling Speaker was tested and found to be compliant with UL2043 requirements by an independent NRTL registerer lab and is therefore suitable for installation in air handling spaces. A copy of the test report is available by request.

Suspended Installation

To suspend the 8198 SIP Ceiling Speaker from a ceiling or truss you will need additional materials not included with the speaker:

- ¼" x20 Redi-Rod or Eyebolt
- Thread locking adhesive
- Load bearing cable or chain

For suspended installations, the trim ring is not used. The four clamps may also be removed for aesthetics. The back housing and grill may be painted if desired but ensure the speaker and wire connectors are properly masked.

Apply a thread locking adhesive and install a ¼-20 eyebolt (not included) into the threaded nut insert on the top of the speaker housing. Screw the eye-bolt in completely (3/8") and use a thread locking adhesive to prevent the bolt from working itself out.

Suspend the speaker using chain or cable rated to support at least 3 x the weight of the speaker and preferably capable of supporting 200 lb (91 kg) loads in case the speaker is used for support while on a ladder. Secure the cable or chain to the speaker and ceiling or truss properly to ensure a safe installation.

Wiring exits from the protective cover towards the center of the housing to be run up the cable or chain and dressed neatly using cable ties.

Wiring Connections

Network Connection

The speaker provides two different RJ45 jacks: one for network connection, and a second for optionally connecting additional 1198 Satellite Speakers. A cable run from the switch can be terminated to a modular jack with connection by patch cord, or terminated with a RJ45 plug.

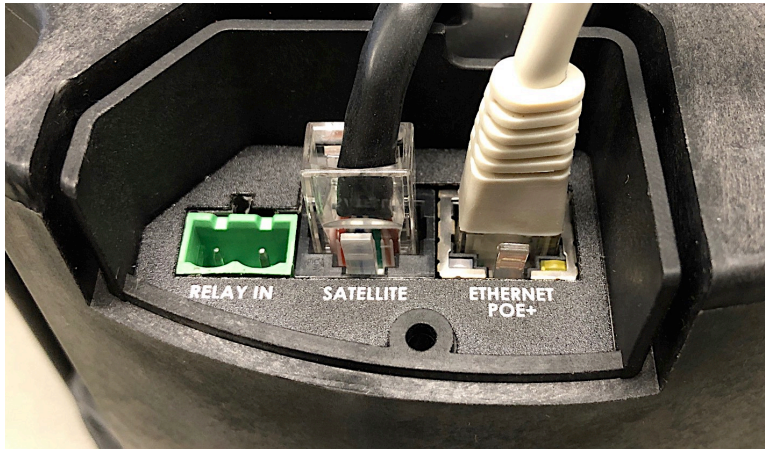

There are two lights on the Ethernet jack:

Green light: On when Ethernet is working, flickers off to indicate activity on the port.

Amber light: Off when successful 100Mbps link is established. Typically on only briefly at power up.

Under normal conditions, the Amber light will turn on immediately after the Ethernet cable is first connected. This indicates that PoE power has been successfully applied. Once the device connects to the network, it will switch to the Green light instead, which will typically flicker indicating traffic on the network.

Connecting Input Devices

The input relay to the 8198 SIP Ceiling Speaker can be prompted by any normally open, normally closed switch, Algo 1202 Call Button, Algo 1203 Call Switch, or Algo 1204 Volume Control Switch. The input switches can be connected to the back of the 8198 via a Terminal Block on the “Relay In” pair. To configure the Relay Input Mode check Additional Features > Input/Output section.

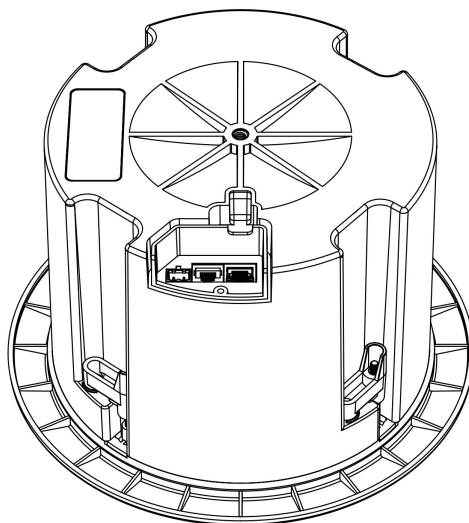

Connecting 1198 satellite speakers (One 8198 with up to three 1198)

The 8198 SIP ceiling speaker is able to drive up to three 1198 satellite speakers. Use an industry standard network cable to connect between the "Satellite" port on the 8198, and the "In" port on the first 1198. Note that this cable will actually carry the analog audio and supervision signals; this interface does not actually use Ethernet. To connect a second 1198, use another cable to connect between the "Out/Term" port on the first 1198, and the "In" port on the second 1198. Regardless of the number of 1198 Satellite Speakers used, connect the Termination Plug to the empty "Out/Term" port on the last 1198 in the chain. The audio will not work without this termination plug being connected. Note that the Status Page in the Web Interface of the 8198 will report the number of 1198 Satellite Speakers connected, as well as the status of the termination plug.

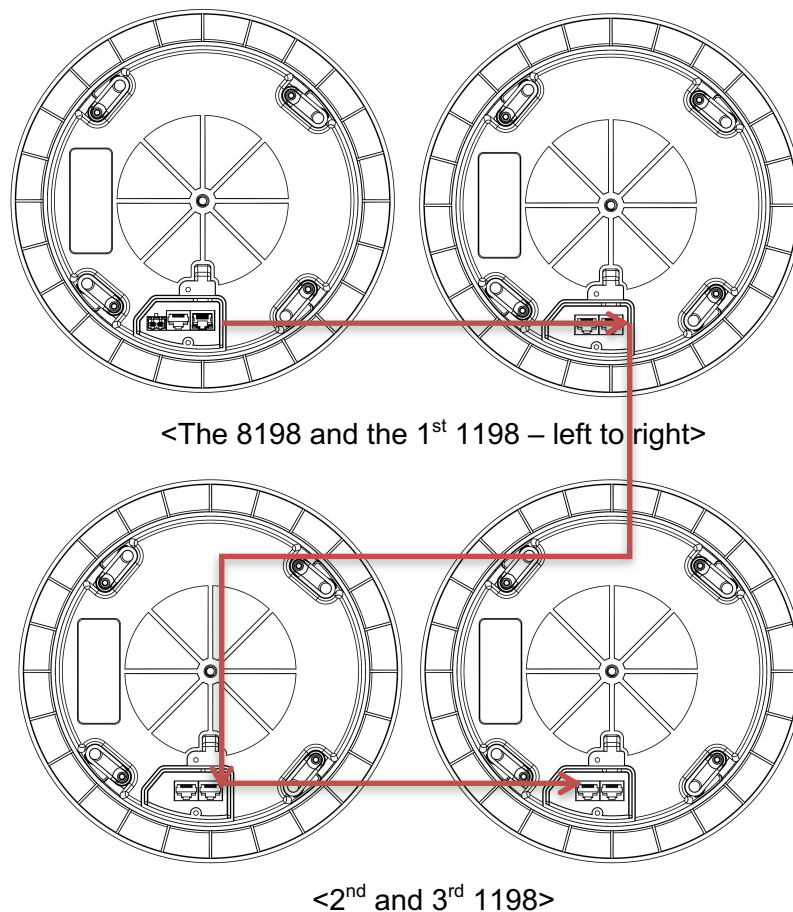

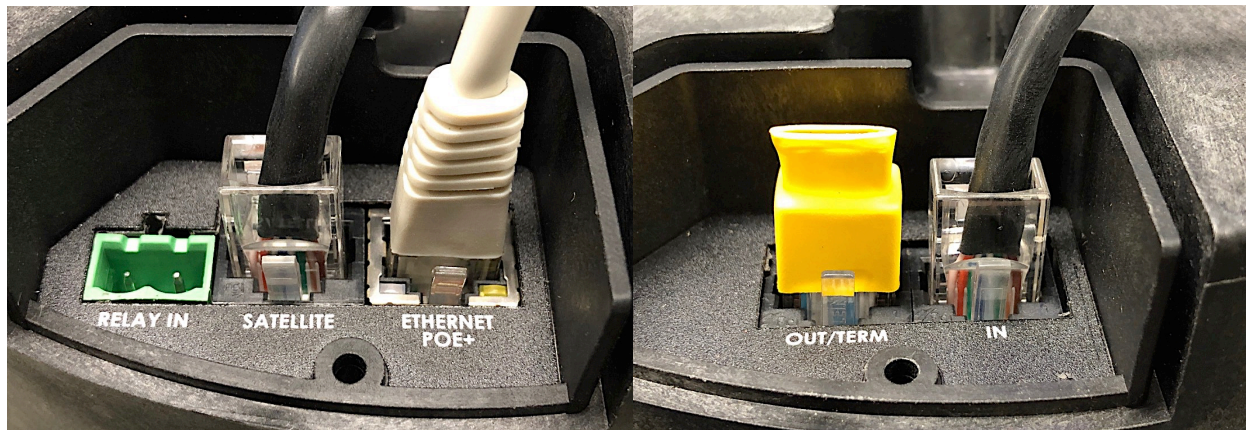

<The 8198 and the 1198 termination plug – left to right>

Reset

A recessed reset button (RST) next to the blue LED can only be used to reset the 8198 SIP Ceiling Speaker at time of power up. To return all the settings to the factory default for the 8198, reboot or power cycle the 8198. Wait until the blue LED flashes and then press and hold the reset button until the blue LED begins a double flash pattern. Release the reset button and allow the unit to complete its boot process.

Do not press the reset button until the LED begins flashing.

A reset will set all configuration options to factory default including the password.

Once booting has completed, pressing the reset button will cause the device to speak its IP address.

Note: The 1198 contains only a speaker. It does not run any firmware nor store any settings, hence it does not have a reset button.

Programming and Configuration

The 8198 SIP Ceiling Speaker is configurable using the web interface or provisioning features.

After connecting the 8198 to a network PoE, the blue indicator light will turn on during initialization. The 8198 will then attempt to obtain an IP address from the DHCP server. If there is no DHCP server or the attempt was unsuccessful, the 8198 will default to the static IP address **192.168.1.111**.

After a successful boot up the blue LED will turn off, and the speaker will have obtained an IP address.

Press the reset switch (RST next to the light) momentarily to hear the IP address over the speaker. The reset switch will not cause a reset unless pressed during power up.

The IP address may also be discovered by downloading the Algo locator tool to find Algo devices on your network: www.algosolutions.com/network-device-locator

Enter the IP address (e.g 192.168.1.111) into a browser such as Chrome, Firefox, or Edge. The web interface should be visible and the default password will be **algo** in lower case letters.

Features

SIP Paging: One 8198 (with or without Satellites)

The 8198 SIP Ceiling Speaker can be registered as a third party SIP extension with a hosted or enterprise Communications Server supporting 3rd party SIP endpoints.

To register the adapter with the SIP server, use the **Basic Settings > SIP** tab in the web interface to enter the Communication Server IP address, extension, username, and password. This information will be available from the IT Administrator.

If VLAN is used, navigate to the **Advanced Settings > Network** tab to set VLAN options.



Important: Once the speaker is using VLAN you will need to be on the same VLAN to access the web interface.

The speaker may now be accessed by dialing its assigned extension from a telephone, device, or client. The adapter will auto-answer, play the default pre-announce tone, and allow voice paging until disconnected.

There are a number of configurable adapter options:

- Increase or Decrease Speaker Volume
- Enable AGC (automatic gain control)
- Enable Ambient Noise Monitoring (speaker volume adapts to background noise)
- Enable Talkback
- Customize pre-announce tone

The best voice paging quality and intelligibility will be obtained using the G.722 wideband audio codec. Most current IP telephones support G.722 which is sometimes referred to as “HD” voice or audio.

SIP Ring Event

Set Monitoring Mode to ‘Monitor Ring’ and enter credentials. When a call is made to the SIP extension the 8198 will play the selected audio file from memory. Often, the 8198 will be part of a hunt group or ring group to ring in conjunction with a telephone.

Multicast Overview

In addition to the ring and page features, the 8198 is able to send and receive IP audio multicast messages over the network to support larger deployment for both paging and ring/notification. This provides a scalable and efficient method of building large scale notification solutions.

An Algo 8198 can be configured as a Master endpoint. When called from a phone, the SIP registered 8198 auto-answers and plays the page audio over its speaker. Simultaneously, the registered 8198 endpoint broadcasts the audio over the network using RTP multicast to any number/combination of Algo IP speakers, paging adapters, and strobes as required.

The Slave endpoints require a PoE network connection but do not require registration to the communication server.

Multicasting can also be used to distribute loud ring or other alerting (e.g. safety, security, or emergency events) over multiple Algo endpoints (e.g. 8180, 8186, 8188, 8198, 8128, 8201, 8301, and 8373).

SIP Paging: Multiple Algo SIP Endpoints (Using Multicast)

Multicast features in the 8198 SIP Ceiling Speaker require that only the ONE of the speaker be registered as a SIP extension. Additional Algo SIP endpoints, including any combination of paging adapters, speakers, and strobes, may be added as multicast Slaves receiving a stream from the SIP registered Master adapter, provided that only a single audio stream will be active at any given time across any or all of the devices. If multiple unique audio streams are needed simultaneously more than one Master device will be required.

The Master speaker will simultaneously stream audio to the Slave speakers. The Slave speaker do not require SIP extensions and do not need to register with the SIP Communication Server.

To enable multicast streaming from the Master speaker, go to the web interface and navigate to the **Basic Settings > Multicast** tab. Choose multicast mode **'Master/Sender'** and pick **'All Call'** for the Master single zone. The multicast addresses pre-populated in the table, under **Advanced Settings > Advanced Multicast** section, will work in most cases and should only be altered for rare cases.

To enable multicast monitoring in the Algo SIP endpoint Slaves, go to the web interface for each endpoint and navigate to the **Basic Settings > Multicast** tab. This time though, choose multicast mode **'Slave/Receiver'**. There is no need to select a zone as the endpoint will automatically monitor the **'All Call'** zone IP address.

The page pre-announce tone is generated from the Master. The speaker volume can be increased or decreased for each multicast Slave individually.



*Note: See **"Basic Setting Tab – Multicast"** section below for more configuration options and instructions.*

SIP Paging: Multiple Speakers (Using Individual SIP extensions)

In some cases it may be desirable for every adapter to have a SIP extension. Multicast may still be used to page multiple speakers, but each speaker can also be called individually or generate a call when appropriately configured.

A speaker configured as a SIP Multicast Slave will give its highest priority to the 'Priority Call' zone. Other than the 'Priority Call' zone, a page using its SIP extension, has priority over all other muticast zones.

Communication Servers with the capability of dialing many SIP extensions simultaneously for paging may be able to create zones by calling "paging groups" in order to page telephone speakers in conjunction with speaker endpoints.

SIP Activated Notification Alerts

In addition to voice paging, the 8198 can play audio files for emergency, safety, and security announcements, customer service, shift changes, etc.

Audio files can be stored in speaker memory and played over the speaker in response to an event such as a ring or relay input, and also multicast to other Algo SIP endpoints on the network. See **Additional Feature > Emergency Alerts** and **Additional Features > Input/Output** for more details.

Background Music Streaming

The 8301 Paging Adapter & Scheduler (sold separately), set as a Multicast master, can stream background music to other Algo slave devices on the network from a music source connected to the 8301's AUX input.

Polycom™ Group Paging

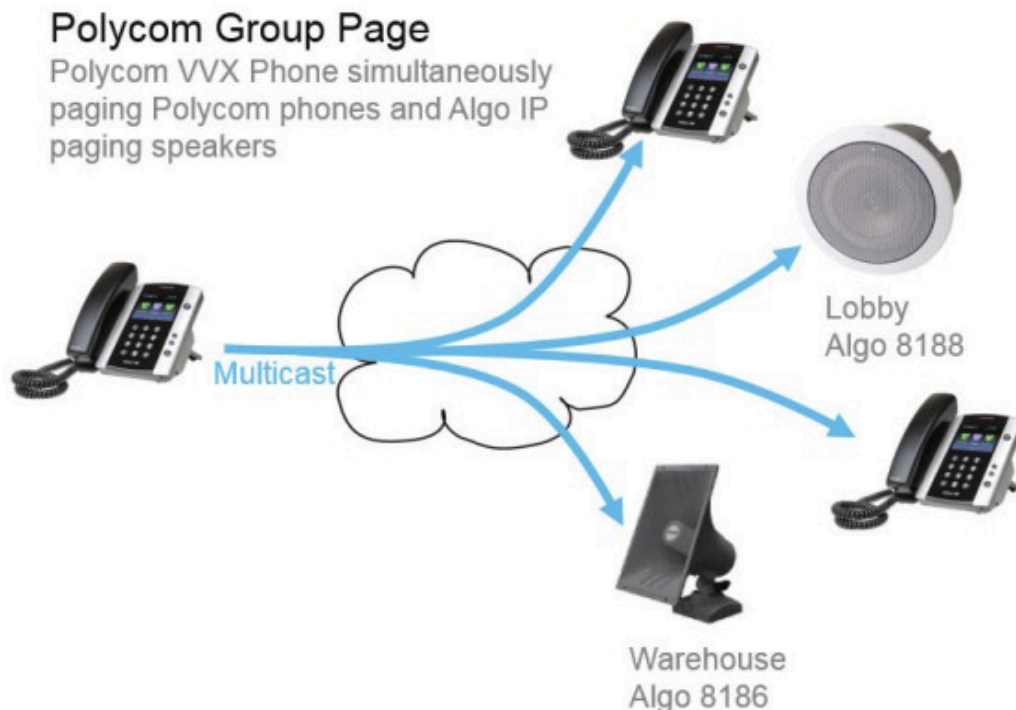

The 8198 SIP Ceiling Speaker has been designed to support Polycom Group Paging.

The 8198 can be added to a Polycom Group Page so that voice paging is heard over Polycom telephone speakers and overhead paging simultaneously.

Polycom Group Paging can be configured on the **Basic Settings > Multicast** tab.

	<p><i>The 8198 Ceiling Speaker may be accessed remotely via SIP and may generate a multicast page within the LAN sending voice page to both Algo paging speakers and Polycom telephones. <u>Audio delay</u> may be added to the 8301 to synchronize with voice page over the Polycom telephone speakers</i></p>
---	---

TLS for SIP Signaling and Provisioning

Algo devices that support firmware 1.6.4 or later support Transport Layer Security (TLS). This feature adds security by ensuring that Algo products can trust the hosted SIP

server. This is useful for when third-party devices or attackers may try to intercept, replicate, or alter Algo products, and try to connect to the server. TLS protocol will ensure that third parties cannot read/modify any actual data. Previously security was less of a concern because phone systems were on isolated networks, but hosted services are becoming increasingly more common. Using a hosted SIP service requires traffic to be sent over the public internet and thus much more susceptible to attacks. Signed certificates are an important piece in the Algo device's operation, to ensure the security, integrity, and privacy of its communication. Algo components that use TLS are **Provisioning** and **SIP Signaling**.

These Algo devices each come pre-loaded with certificates from a list of trusted certificate authorities (CA), which are installed in the hardware at the time of manufacture. Note these pre-installed trusted certificates are not visible to users and are separate from the 'certs' folder.

The TLS handshake happens to make sure that the client and server can trust each other, and once that trust is established, the two parties can freely send encrypted data and decrypt any data that they receive. After the TLS handshake process is complete, a TLS session is established, and the server and client can then exchange messages that are symmetrically encrypted with shared (pre-master) secret key.

For further details reference the [Algo TLS guide for SIP Signalling and HTTPS Provisionings](#).

Uploading Public CA Certificates to Algo SIP Endpoints

To install the public CA certificate on the Algo 8198, follow the steps below:

1. Obtain a public certificate from you Certificate Authority.
2. Rename the public certificate 'siptrusted' with any of supported formats (.pem, .cert, or .cer).
3. In the web interface of the Algo device, navigate to the **System > File Manager** tab.
4. Upload the certificate files into the 'certs' directory. Click the Upload button in the top left corner of the file manager and browser to the certificate.

HTTPS Provisioning

Provisioning can be secured by setting the 'Download Method' to 'HTTPS' (under the **Advanced Settings > Provisioning** tab). This prevents configuration files from being read by an unwanted thrid-party. This resolves the potential risk of having sensitive data stolen, such as admin passwords and SIP credentials.

Status
Basic Settings
Additional Features
Scheduler
Advanced Settings
System
Logout

Network
Admin
Users
Time
Provisioning
Advanced Audio
Advanced SIP
Advanced Multicast

Provisioning Settings

Mode

Provisioning Mode Enabled Disabled

Settings

Server Method Auto (DHCP Option 66/160/150)
 DHCP Option 66 only
 DHCP Option 160 only
 DHCP Option 150 only
 Static
i Auto mode automatically checks all 3 DHCP options for an active provisioning server, in the order listed.

Static Server

Download Method TFTP FTP HTTP HTTPS

Validate Server Certificate Enabled Disabled
i Validate the server against common certificate authorities. To validate against additional certificates, use the "System > File Manager" tab to upload a Base64 encoded X.509 certificate file in .pem, .cer, or .crt format to the 'certs/trusted' folder.

Force Secure TLS Version Enabled Disabled
i Enable this option to require HTTPS connections to use TLSv1.2.

Auth User Name

Auth Password

Config Download Path

Firmware Download Path

Partial Provisioning Enabled Disabled
i Allow support for "-i" incremental provisioning files. Disable for enhanced security if not using this feature.

Save

Important: To verify the server you must 'Enable' the 'Validate Server Certificate' option. This then checks if the certificate that is provided by the server is signed by any of the CAs included in the list of trusted CAs (used by the Debian infrastructure and Mozilla browsers). If we receive a certificate signed by any of these CAs, then that server will be trusted. Certificates can also be manually uploaded using the 'File Manager'.

The 'Validate Server Certificate' parameter can also be enabled through provisioning:
 prov.download.cert = 1

SIP Signalling (and RTP Audio)

SIP signaling is secured by setting 'SIP Transportation' to 'TLS' (under the **Advanced Settings > Advanced SIP** tab). Setting it to 'TLS' ensures that the SIP traffic will be encrypted. The SIP signalling is responsible for establishing the call (the control signal to start and end the call with the other party), but it does not contain the audio.

For the audio (voice) path, use the setting '**SDP SRTP Offer**'. Setting this to '**Optional**', means the SIP call's RTP data will be encrypted (using SRTP) if the other party also support audio encryption. If the other party does not support SRTP, then the call will still proceed, but with unencrypted audio. In order to make audio encryption mandatory for

all calls, set 'SDP SRTP Offer' to 'Standard'. In this case, if the other party does not support audio encryption, then the call attempt will be rejected.

Status	Basic Settings	Additional Features	Scheduler	Advanced Settings	System	Logout	
Network	Admin	Users	Time	Provisioning	Advanced Audio	Advanced SIP	Advanced Multicast

Advanced SIP Settings

General

SIP Transportation:

- Select Auto to check DNS NAPTR record, then try UDP/TCP.
- In TLS mode, if the SIP Server requires endpoints to be authenticated, a PEM file containing both a device certificate and a private key needs to be installed on the Algo device. Use the "System > [File Manager](#)" tab to upload a certificate file renamed to 'sipclient.pem' in the 'certs' folder.

SIPS Scheme: Enabled Disabled

Validate Server Certificate: Enabled Disabled

- Validate the SIP server against common certificate authorities. To validate against additional certificates, use the "System > [File Manager](#)" tab to upload a Base64 encoded X.509 certificate file in .pem, .cer, or .crt format to the 'certs/trusted' folder.

Force Secure TLS Version: Enabled Disabled

- Enable this option to require TLS connections to use TLSv1.2.

SIP Outbound Support (RFC 5626): Enabled Disabled

- Enable this option to support best networking practices according to RFC 5626. This option should generally be enabled if the Algo device is being registered with a hosted server or if TLS is being used for SIP Transportation.

Outbound Proxy:

Register Period (seconds):

Interoperability

Keep-Alive Method: None Double CRLF

- This setting will enable sending periodic CRLF messages for both UDP and TCP connections.

Use Outgoing TLS port in SIP headers: Enabled Disabled

- Use ephemeral port number from outgoing SIP TLS connection instead of listening port number in SIP Contact and Via headers. This is useful to connect the device to some local SIP servers, like Asterisk or FreeSWITCH.

Do Not Reuse Authorization Headers: Enabled Disabled

- When enabled, all SIP authorization information from the last successful request will not be reused in the next request.

Allow Missing Subscription-State Headers: Enabled Disabled

- When enabled, allow SIP NOTIFY messages that do not contain a "Subscription-State" header.



Important: In order for a SIP server to validate the Algo device, an additional certificate has to be installed on the Algo device manually. For Firmware v1.7, the only way to add this user certificate file is to use a '.pem', '.crt', or '.cer' filetype extension and have the file named 'sipclient'. This is done by manually adding a file named 'sipclient', which contains a device certificate and private key, to the 'certs' folder (under the **System > File Manager** tab).

Web Interface Status and Login

Web Interface Login

The web interface requires a password which is 'algo' by default. This password can be changed in the **Admin** tab after logging in the first time.

Status
Basic Settings
Additional Features
Advanced Settings
System
Logout

Device Status

Welcome to the Algo 8198 PoE+ SIP Ceiling Speaker Control Panel

Setting up your PoE+ SIP Ceiling Speaker:

Step 1: Configure your PoE+ SIP Ceiling Speaker

Log in with the default password and use the Basic Settings pages to set up the basic information.

Step 2: Check network settings (Optional)

Use the Network page under the Advanced Settings tab to change network settings. The default setting for the device is to obtain its IP address from a DHCP server. Contact your Network System administrator if you plan to assign a static IP address, Mask, and Gateway to the device.

Step 3: Secure your PoE+ SIP Ceiling Speaker (Optional)

Use the Admin page under the Advanced Settings tab to change the administrator password.
⚠ Changing the password is extremely important if the device is directly connected to a public network.



Step 4: Register your PoE+ SIP Ceiling Speaker (Optional)

Please register your product using the link below:
<http://www.algosolutions.com/register>

Registration ensures your access to the latest upgrades to this product and important service notices.

Status

Device Name	sipceiling-00a07a	
SIP Registration	Page	No Account
Call Status	Idle	
Proxy Status	Single proxy mode	
Provisioning Status	None Found	
MAC	00:22:ee:00:a0:7a	
IPv4	10.30.31.148/8, Gateway: 10.0.1.1	
Date / Time	Tue Aug 18 21:46:45 GMT 2020	
Multicast Mode	Disabled	
Volume	Page Volume: -3 (-39dB) Ring Volume: -5 (-45dB)	
Relay Input Status	Disabled	
1198 Satellite Speaker	Termination Missing	
PoE Detection	PoE 802.3af (Max 12.95W) Some functionality will be reduced due to the present power connection. If using a PoE+ power injector that does not automatically negotiate its power capabilities, see "Advanced Settings > Admin" to manually configure Automatic Power Detection vs Forced PoE+ mode.	
Power Limits	Audio Volume	Level 8 (-6dB)
Power Consumption	2.3W	

	<p><i>The Web Interface is accessed by entering the 8198's IP Address into a web browser.</i></p>
	<p><i>Important: It is highly recommended to change the default password if the device is directly connected to a public network.</i></p>

Status

The device's Status page will be available before and after log on. This section can be used to check the 8198's SIP Registration status of the SIP extensions, Call Status, Proxy Status, Multicast Mode/Status, Volume Status, Relay Input Status, and general MAC, IP, Netmask, and Date/Time information.

	<p><i>The Status page can be hidden when logged out for security purposes under the Advanced Settings > Admin tab.</i></p>
---	--

Web Interface Basic Settings

Basic Settings Tab – SIP

Status Basic Settings Additional Features Advanced Settings System Logout

SIP Features Multicast

SIP Settings

SIP

i This section allows the SIP server information & account credentials to be entered. This information should be obtained from your telephone system administrator or hosted account provider. After saving these settings, see the [Status](#) tab to confirm successful registration.

SIP Domain (Proxy Server)
i Default port is 5060. To specify a different port, enter PROXY:PORT, e.g. my_proxy.com:5070, or 192.168.1.10:5080.

Ring/Alert Mode Monitor "Ring" event on registered SIP extension
 None

Ring Extension

Authentication ID

Authentication Password

Display Name (Optional)

i The device will detect inbound ring events on this extension and play the alerting tone (and multicast if configured) until the inbound call stops ringing. It will not answer the call on this extension.

Page Extension

Authentication ID

Authentication Password

Display Name (Optional)

i The device will auto-answer any inbound call received on this extension and provide a voice paging path (and multicast if configured).

Save

SIP Server information and Credentials should be obtained from your telephone system administrator or hosted account provider. After saving the settings, see the Status tab to confirm the registration was successful.

 **Important:** Any time changes are made to settings in the web interface the 'Save' button must be clicked to save the changes.

SIP Domain (Proxy Server)

The IP address (e.g. 192.168.1.111) or domain name (e.g. myserver.com) of the SIP Server.

Ring / Alert Mode

Option for adding a second SIP extension for Ring event. If activated, screen expands to enter second SIP extension parameters.

The device will detect inbound ring events on this extension and play the alerting tone (and multicast if configured) until the inbound call stops ringing. It will not answer the call on this extension.

Ring Extension

This is the SIP extension for the 8198 speaker's Ring parameter. The device will detect inbound ring events on this extension and play the alerting tone (and multicast if required) until the inbound call stops ringing. It will not answer the call on this extension.

Page Extension

This is the SIP extension for the 8198 speaker. The device will auto-answer any inbound call received on this extension and provide a voice paging path (and multicast if configured).

Authentication ID

May also be called Username for some SIP servers and in some cases may be the same as the SIP extension used for the associated Ring and/or Page extension.

Authentication Password

SIP password provided by the system administrator for the SIP account used for the associated Ring and/or Page parameter.

Display Name

Enter a "Display Name" that will be sent when the SIP call is made. The PBX and phone(s) will have to be configured to display this message as the Caller ID.

Basic Settings Tab – Features

Status
Basic Settings
Additional Features
Advanced Settings
System
Logout

SIP
Features
Multicast

Features

Inbound Ring Settings

i These settings apply to events triggered by the Ring Extension(s) & Emergency Alerts sections. The Play/Loop/Stop buttons can also be used to test the device and set the appropriate volume level.

Ring/Alert Tone	warble2-med.wav	Play	Loop	Stop
Ring/Alert Volume	4	Apply		
	<i>w</i> Caution: The 8186 Horn Speaker is capable of output levels in excess of 120dB at 1 meter. Ensure nobody is in close proximity to the horn, especially during installation and testing of the product.			
Ring Limit	No limit	<i>i</i> 1 ring = 6 seconds.		

Inbound Page Settings

Page Speaker Volume	4	Apply		
	<i>i</i> When in Slave mode, note that this is the default volume control for all audio received via multicast.			
Page Mode	<input checked="" type="radio"/> One-way <input type="radio"/> Two-way <input type="radio"/> Delayed <i>i</i> "Delayed" mode stores the page audio temporarily, and then broadcasts it after the call is hung-up. This can help avoid feedback.			
Page Timeout	5 minutes <i>i</i> Maximum page timeout in Delayed mode is 5 minutes.			
Page Tone	<Default> <i>i</i> Use only Default, or custom uploaded file. The other pre-installed tone files all contain silence at the end in order to generate ring "cadence" of 6 seconds. This silence will block the voice path for several seconds at the start of a page.			
G.722 Support	<input checked="" type="radio"/> Enabled <input type="radio"/> Disabled <i>i</i> Applies to codec used during SIP negotiation only. Multicast codec is configured separately.			
DTMF Detection Type	<input type="radio"/> Auto <input checked="" type="radio"/> RTP Telephony Event (RFC 4733) <input type="radio"/> RTP In-band <input type="radio"/> SIP INFO			

Audio Processing

Ambient Noise Compensation	<input type="radio"/> Enabled <input checked="" type="radio"/> Disabled <i>i</i> Automatically adjust speaker level in response to ambient noise level detected at the device prior to start of each call.			
Automatic Gain Control (AGC)	<input checked="" type="radio"/> Enabled <input type="radio"/> Disabled <i>i</i> Automatically maximize level of voice received from calling phone in order to make page volume more consistent.			

Save

Ring/Alert Tone

Select an audio file to play when a ring event is detected on the SIP Ring extension. The file may be played immediately to the speaker from the web interface for test purposes using the Play, Loop, and Stop buttons. During multicast, the device will broadcast an audio stream using the Master's selected ring tone.

Note: This is the "Default" tone that will be played if selected for Multicast, Additional Ring Extension settings.

Ring/Alert Volume

Set speaker volume for SIP ring event. This setting is an amplifier gain control and the output level will also depend on the levels recorded into the source audio file played from memory. This setting is only used for local tones, and not when receiving multicast (see Page Speaker Volume below).

Ring Limit

Typically set to no limit, this feature can be used to set a limit on how long the speaker will ring before timing out. A new ring event is required before the speaker will play the audio file again.

Page Volume

Speaker page volume control for SIP or multicast paging. This setting is an amplifier gain control and output level will depend on streaming level. This setting will apply to all inbound multicast stream (Slave mode only), regardless of content.

Page Mode

A call to the SIP page extension can be one-way, two-way using an external microphone, or delayed. In delay mode, the speaker will store the page into memory and then play after disconnect.

In delay mode, press "*" to cancel a page while the recording state is in process to prevent it from being sent after hanging up.

Page Timeout

A time limit may be set for an active page.

Page Tone

Select a pre-announce tone for paging. Use only Default, or custom uploaded file. The other pre-installed tone files all contain silence at the end in order to generate ring "cadence" of 6 seconds. This silence will block the voice path for several seconds at the start of a page. The "Default" tone will play the page-notif.wav file.



Note: The "Default Page Tone", in Advanced Multicast, will play the tone set here.

G.722 Support

Enable or disable the G.722 codec.

DTMF Detection Type

Select the preferred DTMF detection method.

Ambient Noise Compensation

To configure, set the volume to an appropriate level for a quiet environment and enable the Ambient Noise Compensation. The integrated microphone will measure the ambient noise during idle periods and automatically increment the speaker volume, if any increase in background noise is detected. Ambient noise level is averaged over 10 seconds. The noise compensation will not be functional when playing background music.

Automatic Gain Control (AGC)

Normalizes the audio level. This ensures audio level heard at the speaker is always at a consistent level, independent of the phone that is used to answer the call.

Basic Settings Tab – Multicast

Multicast IP Addresses

Each 8198 Ceiling Speaker has its own IP address, and shares a common multicast IP and port number (multicast zone) for multicast packets. The master transmits to a configurable multicast zone, and the slave units listen to all the multicast zones assigned to them.

The network switches and router see the packet and deliver it to all the members of the group. The multicast IP and port number must be the same on all the master and slave units of one group. The user may define multiple zones by picking different multicast IP addresses and/or port numbers.

1. Multicast IP addresses range: 224.0.0.0/4 (from 224.0.0.0 to 239.255.255.255)
2. Port numbers range: 1 to 65535
3. By default, the 8198 Ceiling Speaker is set to use the multicast IP address 224.0.2.60 and the port numbers 50000-50008

Make sure that the multicast IP address and port number do not conflict with other services and devices on the same network.

Multicast Page Zones

The 8198 Ceiling Speaker supports nine “basic” multicast zones. These zones are defined by the multicast IP addresses.

Somewhat arbitrarily, these zones are defined below but may be used in other ways. The important consideration is that there is a priority hierarchy – streaming activity on a zone higher on the list, will be treated as a higher priority than a zone lower on the list – with music being the lowest priority.

1. Priority
2. All Call
3. Zone 1
4. Zone 2
5. Zone 3
6. Zone 4
7. Zone 5
8. Zone 6
9. Music

“Expanded” zones can also be enabled, in the **Basic Settings > Multicast** tab, allowing up to 50 zones in total. These have the same behaviors as the basic zones, but are hidden by default to simplify the interface.

Basic Settings Tab – Multicast (Master Settings)

Status
Basic Settings
Additional Features
Advanced Settings
System
Logout

SIP
Features
Multicast

Multicast Settings

Multicast Mode

Multicast Mode None Master/Sender Slave/Receiver
Info Multicast Zone Definitions can be found in "Advanced Settings > [Advanced Multicast](#)".

Multicast Type Regular (RTP)
 Polycom Group Page
 Polycom Push-to-Talk
 Regular RTP + Polycom Group Page
 Regular RTP + Polycom Push-to-Talk
Info Regular mode uses RTP audio packets compatible with all Algo SIP endpoints, and most multicast-enabled phones.

Number of Zones Basic Zones Only Basic and Expanded Zones

Master/Sender Zone Settings

Zone Selection Mode DTMF Selectable Zone Single Zone
Info For additional capabilities allowing unique SIP extensions per zone, see "Additional Features > [More Page Extensions](#)".

Master Single Zone Zone 1

Info If "DTMF Selectable Zone" is selected above, then this single zone setting will not apply to Paging (since the zone can now be dynamically selected per call using DTMF), but it will still apply to the Ring Extension and Relay triggered events.

Speaker Playback Zones
 Priority Call All Call Music
 Zone 1 Zone 2 Zone 3
 Zone 4 Zone 5 Zone 6
Info Allows master device to play audio for selected zones only. This is useful if using DTMF Selectable Zone mode (or [More Page Extensions](#) per zone) and wishing to make the Master unit a member of only certain zones.

Expanded Speaker Playback Zones
 Zone *10 Zone *11 Zone *12 Zone *13 Zone *14
 Zone *15 Zone *16 Zone *17 Zone *18 Zone *19
 Zone *20 Zone *21 Zone *22 Zone *23 Zone *24
 Zone *25 Zone *26 Zone *27 Zone *28 Zone *29
 Zone *30 Zone *31 Zone *32 Zone *33 Zone *34
 Zone *35 Zone *36 Zone *37 Zone *38 Zone *39
 Zone *40 Zone *41 Zone *42 Zone *43 Zone *44
 Zone *45 Zone *46 Zone *47 Zone *48 Zone *49
 Zone *50

Note: See ([Advanced Settings > Advanced Multicast](#)) section for more information on populated IP values.

Multicast Mode (Master/Sender Selected)

If master mode is enabled the 8198 will broadcast an IP stream when activated in addition to playing the audio over its own speaker. (Note that the 8198 cannot be both a multicast Master and Slave simultaneously).

Number of Zones

Select “Basic Zones Only” if configuring nine or fewer multicast zones (shown beside “Speaker Playback Zones”) or select “Basic and Expanded Zones” to configure up to 50 zones. The expanded zones have the same behavior as the basic Slave zones, but are hidden by default to simplify the interface.

Multicast Type

The 8198 Ceiling Speaker may broadcast multicast paging, compatible with Polycom “**on premise group paging**” protocol and most multicast-enabled phones that use RTP audio packets.

Select “Regular” if solely multicasting to Algo SIP endpoints and/or multicast-enabled phones.

To multicast page announcements solely to Polycom phones, select “Polycom Group Page” or “Push-to-Talk”. Then, configure the 8198 with the “Polycom Zone” (IP Address and Port) and “Polycom Default Channel”.

Note: always ensure that the multicast settings on all Slaves match those of the Master.

Select “Regular RTP + Polycom Group Page/Push-to-Talk” to multicast page audio to both Polycom phones, Algo SIP endpoints, and multicast-enabled phones.

Polycom Group Selection Mode

“Single Zone” always broadcasts on one pre-configured Polycom Group. In “DTMF Selectable Zone” mode, the group is determined by the DTMF selection between 1 – 50.



Note: DTMF Codes for groups 10 and higher start with an “”.*

Zone Selection Mode

‘Single Zone’ always broadcasts on one IP address. ‘DTMF Selectable Zone’ mode, offers dynamic zone selection and requires only the master device to have a registered SIP Extension. The zone definitions can be found in the **Advanced Settings > Advanced Multicast** tab.

Zone Selection Mode

‘Single Zone’ mode always broadcasts on one IP address. Note that multiple SIP extensions can be registered on the Master device. Each extension is mapped to a unique zone, allowing zones to be called directly (for instance from speed-dial keys). See **Advanced Settings > Advanced Multicast** tab.

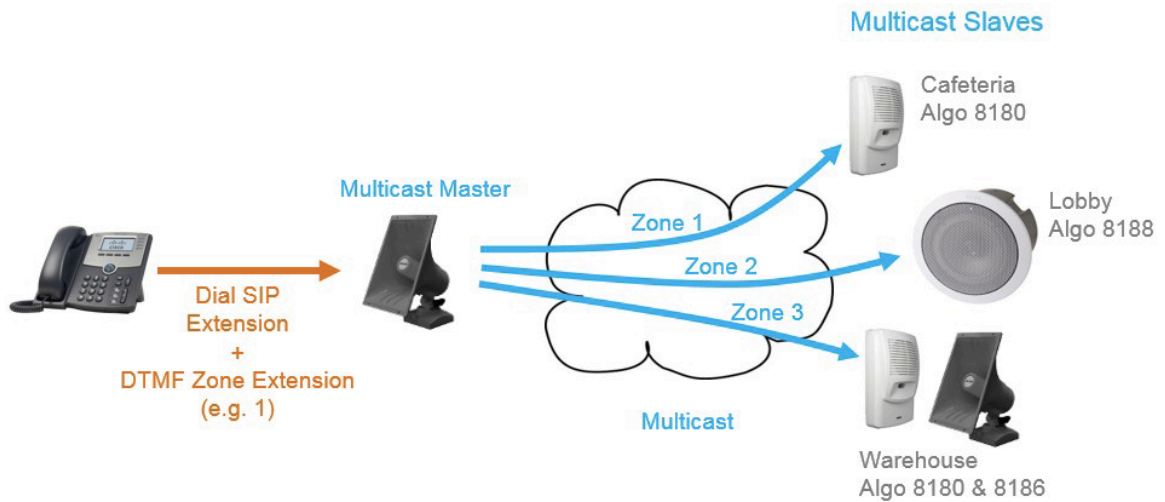

In 'DTMF Selectable Mode', to page, dial the SIP extension of the master device: #####, then dial the desired DTMF page zone (e.g. 1, 2, etc.) on the keypad when prompted.

1. Press DTMF Extension 9 for Priority Call
2. Press DTMF Extension 0 (or 8) for All Call
3. Press DTMF Extension 1 for Zone 1...
4. Press DTMF Extension *10 for Zone 10
5. Press DTMF Extension *11 for Zone 11...

 Note: DTMF codes for zones 10 and higher start with an "*"

Alternatively, multiple SIP extensions can be registered on the Master device. Each extension is mapped to a unique zone, allowing zones to be called directly (for instance from speed-dial keys) without the use of DTMF. See **Additional Features > More Page Extensions** tab.

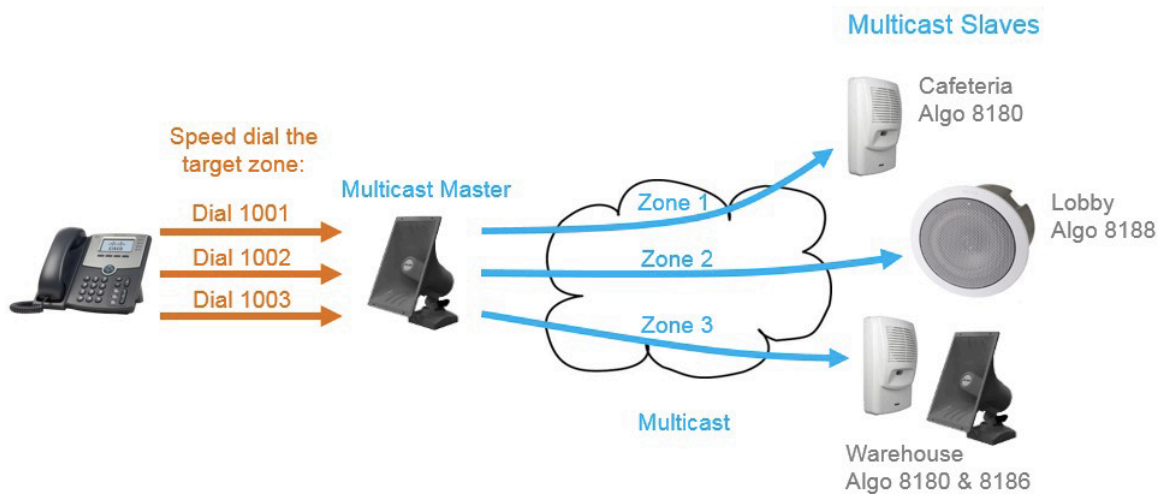

Zone Selection Tone

Only visible when 'Zone Selection Mode' is set to 'DTMF Selectable Zone'. The tone played over the phone to prompt the user to select a zone to multicast to.

Master Single Zone

The zone that multicast stream will be sent to. If ‘DTMF Selectable Zone’ is chosen above, this setting will not apply to Paging, since the zone now must be dynamically selected per call via DTMF. However, the specified ‘Master Single Zone’ setting is still used for any multicast events triggered by the Ring, analog input, or the relay input.

Speaker Playback Zones

Allows Master device to play audio for selected zones only. This is useful if using DTMF Selectable Zone mode (or More Page Extensions per zone) and wishing to make the Master unit a member of only certain zones.

Basic Settings Tab – Multicast (Slave Settings)

The screenshot displays the 'Multicast Settings' configuration page. At the top, there are navigation tabs: Status, Basic Settings (selected), Additional Features, Advanced Settings, System, and Logout. Below these, there are sub-tabs: SIP, Features, and Multicast (selected). The main content area is titled 'Multicast Settings' and is divided into several sections:

- Multicast Mode:** Includes radio buttons for 'None', 'Master/Sender', and 'Slave/Receiver' (selected). A help icon indicates that 'Multicast Zone Definitions can be found in "Advanced Settings > Advanced Multicast".'
- Multicast Type:** Includes radio buttons for 'Regular (RTP)' (selected), 'Polycom Group Page', and 'Polycom Push-to-Talk'. A help icon notes that 'Regular mode uses RTP audio packets compatible with all Algo SIP endpoints, and most multicast-enabled phones.'
- Number of Zones:** Includes radio buttons for 'Basic Zones Only' and 'Basic and Expanded Zones' (selected).
- Slave/Receiver Zone Settings:**
 - Basic Slave Zones:** Includes checkboxes for 'Priority Call' (checked), 'All Call' (checked), and 'Music'. Below are checkboxes for 'Zone 1' through 'Zone 6'.
 - Expanded Slave Zones:** Includes checkboxes for 'Zone *10' through 'Zone *50'.
 - Buttons for 'Select All' and 'Clear All' are located at the bottom of this section.

A green 'Save' button is located at the bottom right of the settings area.

Multicast Mode (Slave Selected)

If Slave mode is enabled the 8198 will activate when receiving a multicast message. It will mimic the audio stream, but use local volume settings (‘Page Speaker Volume’ in Basic Settings > Features).

Multicast Type - Regular

Select “Regular” if receiving multicast from other Algo SIP endpoint(s) and/or multicast-enabled phone(s) that use RTP audio packets.

Number of Zones

Select “basic” zones if configuring nine or fewer multicast zones or “expanded” to configure up to 50 zones. The expanded zones have the same behaviour as the basic slave zones, but are hidden by default to simplify the interface.

Multicast Type – Polycom Group Paging/Push-to-Talk

The 8198 Ceiling Speaker may receive multicast paging compatible with Polycom “**on premise group paging**” protocol.

The screenshot shows the 'Multicast Settings' page in a web browser. At the top, there are navigation tabs: 'Status', 'Basic Settings', 'Additional Features', 'Advanced Settings', 'System', and 'Logout'. Below these, there are sub-tabs: 'SIP', 'Features', and 'Multicast'. The main content area is titled 'Multicast Settings' and contains several sections:

- Multicast Mode:** Radio buttons for 'None', 'Master/Sender', and 'Slave/Receiver' (selected). A help icon and text state: 'Multicast Zone Definitions can be found in "Advanced Settings > Advanced Multicast".'
- Multicast Type:** Radio buttons for 'Regular (RTP)', 'Polycom Group Page' (selected), and 'Polycom Push-to-Talk'. A help icon and text state: 'Regular mode uses RTP audio packets compatible with all Algo SIP endpoints, and most multicast-enabled phones.'
- Polycom Group Paging/ Push-to-Talk:**
 - Polycom Zone:** A text input field containing '224.0.1.116:5001'. A help icon and text state: 'Enter the same Multicast IP Address & Port number as configured on the Polycom phones.'
 - Polycom Slave Channels:** A grid of checkboxes for groups 1 through 25. Groups 1, 24, and 25 are checked. Below the grid are 'Select All' and 'Clear All' buttons.

At the bottom right of the settings area, there is a green checkmark icon and a 'Save' button.

To configure the 8198 as a slave to play Polycom page announcements, select “Group Page” or “Push-to-Talk”. Then enter the Polycom Zone (IP Address and Port) that matches the configuration of the Polycom phones and Channels. The “Default Channel” is the target group in a Polycom paging environment.

The Polycom phone used as page audio source for the 8198(s), must be configured to use either the G.711 or G.722 audio codec. **The Polycom phone(s) must also be configured with the “Compatibility” setting (“ptt.compatibilityMode”) disabled** in order for this codec setting to be applied.

If using a Polycom phone as the Multicast master, a tone may be set for any of the 25 Polycom Groups configured on the Algo device. If an Algo device is used as a Multicast master, a tone does not have to be set as the Algo master will provide its own tone. Polycom Group Tones can be set in **Advanced Settings > Advanced Multicast** tab.

Slave Zones

Select one or more multicast zones for the 8198 to monitor. Note that multicast zone priority is based on the zone definition list order (top to bottom).

Web Interface Additional Features

Additional Features Tab – Input/Output

Status
Basic Settings
Additional Features
Advanced Settings
System
Logout

Input/Output
Emergency Alerts
More Page Extensions
More Ring Extensions

Input/Output

General

Relay Input Mode

- Disabled
- Relay Normally Open
- Relay Normally Open with Supervision (e.g. Algo 1203 Call Switch)
- Relay Normally Closed
- Relay Normally Closed with Supervision
- Mute Switch
- Mute Switch with Supervision
- Algo 1202 Call Button
- Algo 1204 Volume Control Switch
- Algo 1204 Volume Control Switch with Supervision

Action When Input Triggered

Action

- Play Tone Make Two-Way SIP Voice Call Make SIP Call with Tone

ⓘ "Play Tone" will play sound on a local speaker as well as multicast if configured.

Tone/Pre-recorded Announcement:

Tone Duration

- Play Once Play While Held

Action When Tamper Detected

Wiring Fault Supervision Mode

- Detect Open Circuit Fault Only
- Detect Both Open Circuit & Short Circuit Faults

ⓘ Open Circuit detection will trigger when the current draw is <4mA. Short Circuit detection will trigger when the current draw is >36mA. The nominal source voltage on the Relay Input circuit is 13V, with a 40mA current limit.

Action

- Play Tone Make Two-Way SIP Voice Call Make SIP Call with Tone

ⓘ "Play Tone" will play sound on a local speaker as well as multicast if configured. Note that this action will occur 5 seconds after a wiring fault is detected. If the fault is resolved within 5 seconds, this action will not occur.

Tone/Pre-recorded Announcement:

Tone Duration

- Play Once Play While Held

Output

Output Light

- Enabled Disabled

ⓘ Disable the blue light on the speaker entirely (keep the light off even when the speaker is active)

Heartbeat Light

- Enabled Disabled

ⓘ Flash the blue light every 30 seconds to indicate that the speaker is powered and running.

Output Relay

- Enabled Disabled

Save

When triggered by an input relay, the 8198 SIP Ceiling Speaker can perform actions such as playing a pre-recorded announcement over the speaker(s), sending the announcement as a private message to a phone, or initiating a two-way conversation between the speaker and a phone.

Relay Input Mode

The input relay to the 8198(s) can be actuated by any normally open or normally closed switch. Algo offers the 1202 Call Button, the 1203 Call Switch, or the 1204 Volume Control Switch. Via supervision settings, notification actions can also be triggered if the input switch is disconnected.

1203 Call Switch



The 1203 Call Switch is a simple contact closure switch with an illuminated button and supervision capabilities. When used in conjunction with the 8198, the 1203 can prompt a single action with one-touch, or a continuous action if the button is held.

Mute Switch

Apply an external switch (short-circuit) across the Relay Input terminals in order to mute the speaker connected to the 8198. This allows a temporary "disable" switch to control the device if desired, for example in a boardroom to block paging during important meetings.

Leave the Relay Input terminals open (no-connect) for regular full-volume operation when in this mode.

1202 Call Button



The 1202 Call Button is a one-touch button for event notification and response. It can be used with the 8198 for improved customer service, emergency notification, and non-emergency alerting. The Call Button's one-touch button can trigger a single or continuous action, which can be halted via the small cancel/reset button located below the main call button.

While the 8198 can be configured to play the WAV file only once, it can also be enabled to play it continuously with just one touch on the 1202 Call Button. The action can then be stopped via the smaller oval cancel button located below the main call button on the 1202 Call Button.

1204 Volume Control Switch



The 1204 Volume Control Switch is a simple 2 terminal potentiometer that will allow attenuation below the max volume level (configured under 'Basic Settings > Features')

Algo's 1204 can be used for variable volume control. The maximum volume should still be set in the Basic Settings > Features tab as usual, and then the Volume Control Switch will allow attenuation below this level. Enabling Priority Multicast Override allows priority multicast to override the volume set by the Volume Control Switch. Enabling

'Mute On Lowest Setting' allows audio to be completely muted when volume control switch is turned all the way down.

Action – Play Tone

When the 8198 input is triggered, a tone or a pre-recorded WAV file will play over the speaker via the Line Out, or multicast if enabled. This function can be used to call support/assistance in service or retail environments, notify about an emergency at a specific location in medical or educational facilities, or sound an alarm during an intrusion.

- Action When Input Triggered:
 - Tone/Pre-recorded Announcement
 - Tone Duration

Action – Make Two-Way SIP Voice Call

When the 8198 input is triggered, a voice path will open for an intercom-like call via an external microphone (connected to AUX IN) to a pre-configured phone extension. This option can be used when a call needs to be made from a public place where a phone would not be practical to use.

- Action When Input Triggered:
 - Extension to Dial
 - Allow 2nd Button Press
- Outbound SIP Call Settings:
 - Outbound Ring Limit
 - Ringback Tone
 - Maximum Call Duration

Action – Make SIP Call with Tone

When the 8198 input is triggered, a private call can be generated to a pre-configured phone extension with a pre-recorded message. For instance, a call to a supervisor's phone notifying about an emergency or intrusion at some location.

- Action When Input Triggered:
 - Extension to Dial
 - Allow 2nd Button Press
 - Tone/Pre-recorded Announcement
 - Interval Between Tone (seconds)
 - Maximum Tone Duration
- Outbound SIP Call Settings:
 - Outbound Ring Limit

Action When Tamper Detected (Supervision)

In addition to the main events, the device can be configured with supervision to also execute one of the above three actions ('Play Tone', 'Make Two-way SIP Voice Call', 'Make SIP Call with Tone') in case the device goes offline due to wiring failure or after being tampered with. For example, a tone could sound over the speaker(s), or a private pre-recorded message could be sent to a specified phone extension. The supervision

configuration options will appear once a relay option with supervision is selected. See the Electrical Specification section for details on supervision detection circuit.

Extension to Dial

SIP account required in Page Extension fields in order to make a call. Can be configured if 'Make SIP Voice Call' or 'Make SIP Call with Tone' actions are enabled under 'Call Button Settings'.

Interval Between Tones

Specify the time delay (seconds) between tones. Can be configured if 'Play Tone' or 'Make SIP Call with Tone' actions are enabled under 'Call Button Settings'.

Maximum Tone Duration

Select the maximum tone duration. The tone will be terminated once the maximum time is reached. Can be configured if 'Play Tone' or 'Make SIP Call with Tone' actions are enabled.

Allow 2nd Button Press

If enabled, 2nd button press will either simply End Call or End and Restart Call. Therefore, if an input is triggered for the second time the SIP call will either simply be terminated or terminated and immediately called again.

Outbound Ring Limit

Typically set to ensure that a call will not reach voicemail. This feature, under 'Outbound SIP Call Settings', can be used to set a limit on how long the speaker will ring before timing out.

Ring back Tone

If enabled, under 'Outbound SIP Call Settings', a ringback tone will play over the speaker during an outbound SIP call, while waiting for the far-end party to answer.

Maximum Call Duration

Select the maximum call length. The call will be terminated once the maximum time is reached. In the event that a call inadvertently reaches voicemail or gets accidentally left on hold, this setting ensures that the 8198 returns on-hook.

Output Light

Enable/Disable the blue light on the speaker entirely (keep the light off even when the speaker is active).

Heartbeat Light

If enabled, the small blue indicator will flash every 30 seconds as visual confirmation that the 8198 is powered and running.

Additional Features Tab – Emergency Alerts

Status Basic Settings **Additional Features** Advanced Settings System Logout

Input/Output **Emergency Alerts** More Page Extensions More Ring Extensions

Emergency Alerts

i This section allows pre-recorded announcements to be triggered & latched by calling an extension and hanging up. The announcement will continue to play until a different "Cancel" extension is called to clear the announcement (or a pre-defined timeout is reached). This can be useful for emergency notifications (e.g. "Evacuation Alert"), allowing staff to quickly dial a pre-configured number and then exit the building. Audio files can be easily uploaded to create custom announcements.

i Up to 10 extensions can be registered allowing up to 10 different announcements. A single "Cancel" extension also needs to be registered; calling this number will cancel the currently active announcement.

i Note: Some SIP phone systems may not support this feature if they limit the number of extensions that can be registered on a single device.

Settings

Announcement Duration Play Once Play Until Cancelled

Maximum Announcement Time

Answer Inbound Call Enabled Disabled

i This option selects how the Announcement calls are handled. In both cases, the Emergency Announcement is started when the appropriate extension is called and continues until the Cancel Extension is called.

i Select "Enabled" to answer the inbound call and provide the option to play a confirmation tone before starting the alert, then automatically release the call.

i Select "Disabled" to detect just the inbound Ring signal, but not actually answer the call

Call-to-Cancel

Extension

Authentication ID

Authentication Password

Display Name (Optional)

Announcements

Announcement 1 Enabled Disabled

Extension

Authentication ID

Authentication Password

Display Name (Optional)

Tone/Pre-recorded Announcement

Announcement 2 Enabled Disabled

Announcement 10 Enabled Disabled

Save

Emergency Alerts allow for an announcement to be triggered & latched by calling a preconfigured Emergency extension and hanging up. The announcement can be chosen to play once or to play until cancel. "Play Once" mode will play a single cycle of the chosen tone file, despite of its duration. If "Play Until Cancelled" is selected, the announcement will continue to play until the "Call-to-Cancel" extension is called to clear the announcement (or a defined timeout is reached). The Emergency Alerts are useful for emergency notifications (e.g. evacuation, lock down, medical emergency, etc.), allowing staff to quickly dial a pre-configured number under such circumstances.

To configure an emergency alert extension click "Enable" beside the target announcement and enter the Extension, Authentication ID, and Authentication password.

If the "Answer Inbound Call" option is "Enabled" the call is auto-answered and a configurable confirmation tone is played before starting the alert. If "Disabled", the alert is triggered just by the inbound ring, without answering the call. (In both instances, the announcement will play until the time limit is reached or the "Cancel Extension" is called). The auto-answering option can be useful when the caller cannot hear announcement from their location. However, in instances where the call might go to a group/multiple extensions (including this device), the auto-answer may intercept that call and prevent it from ringing on other devices.

Up to 10 extensions can be registered allowing up to 10 different announcements. Audio files can also be easily uploaded to create custom announcements. Only one "Call-to-Cancel" extension is needed, despite the number of the alert extensions.



Note: Some SIP phone systems may not support this feature if they limit the number of extensions that can be registered on a single device.

Additional Features Tab – More Page Extensions

Status Basic Settings **Additional Features** Advanced Settings System Logout

Input/Output Emergency Alerts **More Page Extensions** More Ring Extensions

More Page Extensions

This section allows dedicated extensions to be registered for each paging zone. This provides an alternative to the "DTMF Selectable Zone" option, thus allowing any zone to be called directly without the need to enter DTMF. Depending on the features available on your SIP phone system, this can provide benefits in allowing speed-dial keys to be programmed on user phones for paging a particular zone more easily, or dialing restrictions could potentially be used to allow only selected phones to access certain zones. This feature requires several SIP extensions to be registered with the SIP phone system.

- The 8186 will auto-answer any inbound calls received on these numbers and provide a voice paging path and multicast if configured. Note that only a single call can be active at a time.
- Note: Some SIP phone systems may not support this feature if they limit the number of extensions that can be registered on a single device.
- Multicast Zone Definitions can be found in "Advanced Settings > [Advanced Multicast](#)".

Basic Extensions

Priority Call Page Extension	<input type="radio"/> Enabled <input checked="" type="radio"/> Disabled
All Call Page Extension	<input type="radio"/> Enabled <input checked="" type="radio"/> Disabled
Zone 1 Page Extension	<input type="radio"/> Enabled <input checked="" type="radio"/> Disabled
Zone 2 Page Extension	<input type="radio"/> Enabled <input checked="" type="radio"/> Disabled
Zone 3 Page Extension	<input type="radio"/> Enabled <input checked="" type="radio"/> Disabled
Zone 4 Page Extension	<input type="radio"/> Enabled <input checked="" type="radio"/> Disabled
Zone 5 Page Extension	<input type="radio"/> Enabled <input checked="" type="radio"/> Disabled
Zone 6 Page Extension	<input type="radio"/> Enabled <input checked="" type="radio"/> Disabled
Music Page Extension	<input type="radio"/> Enabled <input checked="" type="radio"/> Disabled

Expanded Extensions

Zone 10 Page Extension	<input type="radio"/> Enabled <input checked="" type="radio"/> Disabled
Zone 11 Page Extension	<input type="radio"/> Enabled <input checked="" type="radio"/> Disabled

Additional SIP extensions can be registered for each multicast zone that will be used. This allows the advantage of dialing directly to a zone without needing to enter DTMF Codes (e.g. speed-dial keys can be used), but this may require additional SIP licenses depending on the SIP provider.

To configure additional page extensions (up to 50) click "Enable" beside the target extension and enter the Extension, Authentication ID, and Authentication password.

The 8198 will auto-answer any inbound calls received on these numbers and provide a voice paging path and multicast if configured. Note that only a single call can be active at a time.



Note: Some SIP phone systems may not support this feature if they limit the number of extensions that can be registered on a single device.

Multicast Zone Definitions can be found in Advanced Settings > [Advanced Multicast](#).

Additional Features Tab – More Ring Extensions

Status Basic Settings **Additional Features** Advanced Settings System Logout

Input/Output Emergency Alerts More Page Extensions **More Ring Extensions**

More Ring Extensions

i This section allows additional extensions to be registered for the purpose of providing loud ringing alerts for more than one line. Unique ring tones can be selected for each line to allow them to be easily distinguished - for example a "Sales" line could have a different ring tone from a personal line. Appropriate call routing must be configured on your SIP phone system of course in order to trigger it to send calls to these different numbers.

i The 8186 will detect inbound ring events on these numbers and play the alerting tone until the inbound call stops ringing. It will not answer the calls in this mode.

i Note: Some SIP phone systems may not support this feature if they limit the number of extensions that can be registered on a single device.

Ring Extension 2	<input checked="" type="radio"/> Enabled <input type="radio"/> Disabled
Extension	<input type="text"/>
Authentication ID	<input type="text"/>
Authentication Password	<input type="password"/>
Display Name (Optional)	<input type="text"/>
Ring Tone	<input type="text" value="<Use Default Ring Tone->"/>
Multicast Zone	<input type="text" value="<Use Default Multicast Zone->"/>
Ring Extension 3	<input type="radio"/> Enabled <input checked="" type="radio"/> Disabled
Ring Extension 4	<input type="radio"/> Enabled <input checked="" type="radio"/> Disabled
Ring Extension 5	<input type="radio"/> Enabled <input checked="" type="radio"/> Disabled
Ring Extension 6	<input type="radio"/> Enabled <input checked="" type="radio"/> Disabled
Ring Extension 7	<input type="radio"/> Enabled <input checked="" type="radio"/> Disabled
Ring Extension 8	<input type="radio"/> Enabled <input checked="" type="radio"/> Disabled
Ring Extension 9	<input type="radio"/> Enabled <input checked="" type="radio"/> Disabled
Ring Extension 10	<input type="radio"/> Enabled <input checked="" type="radio"/> Disabled

Save

Up to 10 SIP Ring extensions can be registered. To configure additional ring extensions, click "Enable" beside the target extension and enter the Extension, Authentication ID, and Authentication password. A unique Ring Tone and Multicast Zone can be assigned to each extension if desired.

 *Note: It is recommended that Provisioning Mode be set to Disabled if this feature is not in use. This will prevent unauthorized re-configuration of the device if DHCP is used.*

Web Interface Advanced Settings

Advanced Settings Tab – Network

Status Basic Settings Additional Features **Advanced Settings** System Logout

Network Admin Time Provisioning Advanced Audio Advanced SIP Advanced Multicast

Network Settings

Common

Internet Protocol

Supersede DNS from DHCP Enabled Disabled

IPv4

IPv4 Method Static DHCP

IPv4 Address
Address (dot delimited)/Netmask (CIDR), e.g. 192.168.1.23/24

IPv4 Gateway

IPv6

IPv6 Method Static DHCP

802.1Q Virtual LAN

VLAN Mode None Manual Auto

VLAN ID
Value range: 0 to 4094

VLAN Priority
Value range: 0 to 7

802.1X Port-based Network Access Control

802.1X Authentication Enabled Disabled

ID

Password

Differentiated Services

SIP (6-bit DSCP value)
Valid values range from 0 to 63

RTP (6-bit DSCP value)
Valid values range from 0 to 63

RTCP (6-bit DSCP value)
Valid values range from 0 to 63

DNS

DNS Caching Mode Disabled SIP All
In "SIP" mode, only the results of DNS queries for SIP requests will be cached. In "All" mode, the results of all DNS queries will be cached.

Save

Internet Protocol

The 8198 can be set to have IPv4 only or both IPv4 and IPv6 method as its internet protocol.

IPv4/IPv6 Method

The 8198 can be set to a DHCP or a static IP address. When DHCP is selected, DHCP will automatically configure IP addresses for each 8198 Ceiling Speaker on the network.

IPv4/IPv6 Address

Enter the static IP address for the 8198.

IPv4/IPv6 Address

Enter the gateway address.

VLAN Mode

Enables or Disables VLAN Tagging. VLAN Tagging is the networking standard that supports Virtual LANs (VLANs) on an Ethernet network. The standard defines a system of VLAN tagging for Ethernet frames and the accompanying procedures to be used by bridges and switches in handling such frames. The standard also provides provisions for a quality of service prioritization scheme commonly known as IEEE 802.1p and defines the Generic Attribute Registration Protocol.

VLAN ID

Specifies the VLAN to which the Ethernet frame belongs. A 12-bit field specifying the VLAN to which the Ethernet frame belongs. The hexadecimal values of 0x000 and 0xFFE are reserved. All other values may be used as VLAN identifiers, allowing up to 4094 VLANs. The reserved value 0x000 indicates that the frame does not belong to any VLAN; in this case, the 802.1Q tag specifies only a priority and is referred to as a priority tag. On bridges, VLAN 1 (the default VLAN ID) is often reserved for a management VLAN; this is vendor specific.

VLAN Priority

Sets the frame priority level. Otherwise known as Priority Code Point (PCP), VLAN Priority is a 3-bit field which refers to the IEEE 802.1p priority. It indicates the frame priority level. Values are from 0 (lowest) to 7 (highest).

802.1x Authentication

Credentials to access LAN or WLAN that have 802.1X network access control (NAC) enabled. This information will be available from the IT Administrator.

Differentiated Services (6-bit DSCP value)

Provides quality of service if the DSCP protocol is supported on your network. Can be specified independently for SIP control packets versus RTP and RTCP audio packets.

DNS Caching Mode

In "SIP" mode, only the results of DNS queries for SIP requests will be cached. In "All" mode, the results of all DNS queries will be cached.

Advanced Settings Tab – Admin

The screenshot displays the 'Admin Settings' configuration page. At the top, there are navigation tabs: Status, Basic Settings, Additional Features, **Advanced Settings**, System, and Logout. Below these are sub-tabs: Network, **Admin**, Time, Provisioning, Advanced Audio, Advanced SIP, and Advanced Multicast. The main content area is titled 'Admin Settings' and is divided into three sections:

- Admin Password:** Contains two input fields, 'Password' and 'Confirmation', each with a reset icon to its right.
- General:** Contains several settings:
 - Device Name (Hostname): A text input field containing 'siphorn-\$MAC\$'.
 - Introduction Section on Status Page: Radio buttons for 'On' (selected) and 'Off'.
 - Show Status Section on Status Page when: Radio buttons for 'On' (selected) and 'Off'.
 - Logged Out: Radio buttons for 'On' and 'Off' (selected).
 - Display Switch Port ID on Status Page: Radio buttons for 'On' and 'Off' (selected). A tooltip indicates: 'Requires the device to be connected to a switch that supports LLDP or CDP.'
 - Web Interface Session Timeout: A dropdown menu set to '1 hour'. A tooltip indicates: 'Automatically log out web interface after period of inactivity.'
 - Play Tone at Startup: Radio buttons for 'Enabled' (selected) and 'Disabled'. A tooltip indicates: 'A tone can be played at startup to confirm that the device has booted.'
- Log Settings:** Contains two rows:
 - Log Level: Radio buttons for 'Error (Lowest)', 'Notice ("Event")', 'Info ("SIP")' (selected), and 'Debug (Highest)'.
 - Log Method: Radio buttons for 'Local' (selected), 'Network', and 'Both'.

Password

Password to log into the 8198 Ceiling Speaker web interface. You should change the default password **algo** in order to secure the device on the network. If you have forgotten your password, you will need to perform a reset using the Reset Button in order to restore the password (as well as all other settings) back to the original factory default conditions.

For additional password security see “Force Strong Password” below.

Confirmation

Re-enter network admin password.

Device Name (Hostname)

Name to identify the device in the Algo Network Device Locator Tool.

Introduction Section on Status Page

Allows the introduction text to be hidden from the login screen.

Show Status Section on Status Page when Logged Out

Use this option if you wish to block access to the status page when logged out. The settings and configurations, on the status page, will be hidden entirely unless you're logged in – this feature is useful when you want only trusted users to view possible sensitive device information.

Logged Out Display Switch Port ID on Status Page

When enabled,

Web Interface Session Timeout

Set the maximum period of inactivity after which the web interface will log out automatically.

Play Tone at Startup

A tone can be played at startup to confirm that the device has booted.

Log Level

Use on the advice of Algo technical support only.

Log Method

Allows the 8198 to write to external Syslog server if the option for external (or both) is selected.

Log Server

If “Network” or “Both” is selected this is the address of the Syslog server on the network.

Management

Web Interface Protocol Both HTTP and HTTPS HTTPS Only

Force Strong Password Enabled Disabled

Allow Secure SIP Passwords Enabled Disabled
i After enabling this option, it is recommended to re-enter SIP passwords and their corresponding realm to store the passwords securely.

Simple Network Management Protocol

SNMP Support Enabled Disabled
i Download MIB file [here](#).

API Support

RESTful API Enabled Disabled
i Secure API for remote access & control via HTTP. Contact Algo Support for more information

System Integrity

System Integrity Checking Enabled Disabled
i This feature verifies installed system packages to ensure they have not been tampered with. Enabling this feature may cause reboots and upgrades to take 30 seconds longer. Verification results can be found on the Status page.

Syn-Apps

SA-Announce Support Enabled Disabled

SA-Announce Server
i Leave this field blank to use the server provided by DHCP Option 72.

Local Management Port

InformaCast

InformaCast Support Enabled Disabled
i This feature requires a valid license to be activated. Please contact sales@algosolutions.com for assistance.

Save

Web Interface Protocol

The HTTPS is always enabled on the device. Use 'HTTPS Only' to disable HTTP, then requests will be automatically redirected to HTTPS. Also note that since the device can have any address on the local network, no security certificate exists, and thus most browsers will provide a warning when using HTTPS.

Force Strong Password

When enabled, ensures that a secure password is provided for the device's web interface for additional protection. The password requirements are:

- Must contain at least 10 characters
- Must contain at least 1 uppercase character

- Must contain at least 1 digit (0 – 9)
- Must contain at least 1 special character

Allow Secure SIP Password

Allows SIP passwords to be stored in the configuration file in an encrypted format, to prevent viewing and recovery. Once enabled, the SIP “Realm” field should be entered and all the configured Authentication Password(s) must be re-entered in the Basic Settings > SIP tab, and any other locations where SIP extension have been configured, to save the encrypted password(s).

If the Realm is changed at a later time, all the passwords will also need to be re-entered again to save the passwords with the new encryption.

To obtain your SIP Realm information, contact your SIP Server administrator (or check the SIP log file for a registration attempt). The Realms may be the same or different for all the extensions used.

SNMP Support

Additional SNMP support is anticipated for future. Currently the 8198 will respond to a simple status query for automated supervision. Contact Algo technical support for more information.

RESTful API

Secure API for remote access & control via HTTP.

System Integrity Checking

This feature verifies installed system packages to ensure they have not been tampered with by running ‘Perform Check’. Enabling this feature may cause reboots and upgrades to take 30 seconds longer. Verification results can be found on the Status page.

SA-Announce Support

Syn-Apps Revolution paging application converts unicast streams to multicast and delivers them to the target endpoints. The feature can only be used on the 8198 when Multicast Master Mode is disabled (set to ‘None’) in the Basic Settings > Multicast tab.

SA-Announce Server

Enter the SA-Announce Server to use the Syn-Apps paging feature. To use the server provided by the DHCP Option 72, leave the field blank.

Local Management Port

Enter the local management port for the SA-Announce Server.

InformaCast Support

This feature requires a valid InformaCast license to be activated. Please contact sales@algosolutions.com for assistance.

Advanced Settings Tab – Time

Status
Basic Settings
Additional Features
Advanced Settings
System
Logout

Network
Admin
Time
Provisioning
Advanced Audio
Advanced SIP
Advanced Multicast

Time Settings

General

Timezone	GMT
NTP Time Server 1	0.debian.pool.ntp.org
NTP Time Server 2	1.debian.pool.ntp.org
NTP Time Server 3	2.debian.pool.ntp.org
NTP Time Server 4	3.debian.pool.ntp.org
Supersede NTP from DHCP	<input type="radio"/> Enabled <input checked="" type="radio"/> Disabled <small>i By default, if an NTP Server address is provided via DHCP Option 42, it will be used instead of the NTP servers listed below. Enable this option to ignore DHCP Option 42.</small>

Device Date/Time: Fri May 15 04:17:44 2020 Sync with browser

Manually Override Time: 04:17:29 Manually Set Time

i Manual time and date are intended for testing purpose only. Time will be lost upon power down if NTP server is reachable.

✔ Save

Network time is used for logging events into memory for troubleshooting.

Timezone

Select time zone.

NTP Time Servers 1/2/3/4

The interface will attempt to use Timer Server 1 and work down the list if one or more of the time servers become unresponsive.

NTP Time Server Source

When “Use DHCP Option 42” is chosen, if an NTP Server address is provided via the DHCP Option 42, that NTP Server will be used instead of the 4 mentioned above. Alternatively, “Ignore DHCP Option 42” can be chosen to only use servers mentioned above.

Device Date/Time

This field shows the current time and date as set on the device. If testing the device on a lab network that may not have access to an external NTP server, the “Sync with browser” button can be used to temporarily set the time on the device.

Note: This time value will be lost at power down, or overwritten if NTP is currently active. Time and date are used for logging purposes and for the scheduler feature.

Advanced Settings Tab – Provisioning

Status
Basic Settings
Additional Features
Advanced Settings
System
Logout

Network
Admin
Time
Provisioning
Advanced Audio
Advanced SIP
Advanced Multicast

Provisioning Settings

Mode

Provisioning Mode Enabled Disabled

Settings

Server Method Auto (DHCP Option 66/160/150)
 DHCP Option 66 only
 DHCP Option 160 only
 DHCP Option 150 only
 Static
i Auto mode automatically checks all 3 DHCP options for an active provisioning server, in the order listed.

Static Server

Download Method TFTP FTP HTTP HTTPS

Validate Server Certificate Enabled Disabled
i Validate the server against common certificate authorities. To validate against additional certificates, use the "System > [File Manager](#)" tab to upload a Base64 encoded X.509 certificate file in .pem, .cer, or .crt format to the 'certs/trusted' folder.

Force Secure TLS Version Enabled Disabled
i Enable this option to require HTTPS connections to use TLSv1.2.

Auth User Name

Auth Password

Config Download Path

Firmware Download Path

Partial Provisioning Enabled Disabled
i Allow support for "-i" incremental provisioning files. Disable for enhanced security if not using this feature.

Save

Note: It is recommended that Provisioning Mode be set to Disabled if this feature is not in use. This will prevent unauthorized re-configuration of the device if DHCP is used.

Provisioning allows installers to pre-configure the 8198 SIP Ceiling Speaker PoE+ units prior to installation on a network. It is typically used for large deployments to save time and ensure consistent setups.

The device can be provisioned via the Auto mode (where all three DHCP options (Option 66/160/150) will be automatically checked for an active provisioning server), just one of the three specified DHCP options, or a Static Server. In addition, there are four

different ways to download provisioning files from a “Provisioning Server”: TFTP (Trivial File Transfer Protocol), FTP, HTTP, or HTTPS.

For example, the 8198 configuration files can be automatically downloaded from a TFTP server using DHCP Option 66. This option code (when set) supplies a TFTP boot server address to the DHCP client to boot from.



Important: DHCP must be enabled if using DHCP Option 66/160/150, in order for Provisioning to work.

One of two files can be uploaded on the Provisioning Server (for access via TFTP, FTP, HTTP, or HTTPS):

Generic (for all Algo 8198 SIP Ceiling Speaker PoE+) **algop8198.conf**

Specific (for a specific MAC address) **algom[MAC].conf**

Both protocol and path is supported for Option 66, allowing for <http://myserver.com/config-path> to be used.

MD5 Checksum

In addition to the **.conf** file, an **.md5** checksum file must also be uploaded to the Provisioning server (for TFTP mode only). This checksum file is used to verify that the **.conf** file is transferred correctly without error.

A tool such as can be found at the website address below and may be used to generate this file: <http://www.fourmilab.ch/md5>

The application doesn't need an installation. To use the tool, simply unzip and run the application (md5) from a command prompt. The proper **.md5** file will be generated in the same directory.

If using the above tool, be sure to use the “-l” parameter to generate lower case letters.

Generating a generic configuration file

1. Connect the 8198 to the network
2. Access the 8198 Web Interface Control Panel
3. Configure the 8198 with desired options
4. Click on the System tab and then Maintenance.
5. Click “Download” to download the current configuration file
6. Save the file settings.txt
7. Rename file settings.txt to algop8198.conf
8. The file algop8198.conf can now be uploaded onto the Provisioning server

If using a generic configuration file, extensions and credentials have to be entered manually once the 8198 has automatically downloaded the configuration file.

Generating a specific configuration file

1. Follow steps 1 to 6 as listed in the section “Generating a generic configuration file”.
2. Rename file settings.txt to algom[MAC address].conf (e.g. algom0022EE020009.conf)
3. File algom[MAC address].conf can now be uploaded on the Provisioning server.

The specific configuration file will only be downloaded by the 8198 with the MAC address specified in the configuration file name. Since all the necessary settings can be included in this file, the 8198 will be ready to work immediately after the configuration file is downloaded. The MAC address of each 8198 can be found on the back label of the unit.

For more Algo SIP endpoint provisioning information, see: [Algo provisioning guide](#).

Advanced Settings Tab – Advanced Audio

The screenshot shows the 'Advanced Audio Functions' configuration page. At the top, there are navigation tabs: Status, Basic Settings, Additional Features, **Advanced Settings**, System, and Logout. Below these are sub-tabs: Network, Admin, Time, Provisioning, **Advanced Audio**, Advanced SIP, and Advanced Multicast. The main content area is titled 'Advanced Audio Functions' and is divided into three sections: 'Functions', 'Audio Filters', and 'Microphone'.
- **Functions:** Dynamic Range Compression (DRC) is set to 'Enabled'. Dynamic Range Compression Gain is set to '6'. Jitter Buffer Range (milliseconds, 10 ~ 500) is set to '100'. Always Send RTP Media is set to 'Enabled'.
- **Audio Filters:** Speaker Filter is set to 'None'. Speaker Noise Filter is set to 'Disabled'. Microphone Filter is set to 'None'. Microphone Noise Filter is set to 'Disabled'.
- **Microphone:** Microphone Volume is set to 'Low'.
A 'Save' button with a green checkmark is located at the bottom right of the configuration area.

Dynamic Range Compression (DRC)

If enabled, compresses the dynamic range of page audio to increase loudness.

Dynamic Range Compression Gain

Higher compression gain increases distortion.

Jitter Buffer Range

The jitter buffer removes the jitter in arriving network packets by temporarily storing them. This process corrects the inconsistent delays on the network. It is recommended to use the lowest value.

Always Send RTP Media

If enabled, audio packets will be sent at all times, even during one-way paging mode. This option is needed in cases when the server expects to see audio packets at all times.

Speaker Filter

Applies a high-pass filter to the speaker output. Used to reduce audio artifacts like humming or buzzing by filtering out unwanted frequencies.

Speaker Noise Filter

Enables heavy filtering below 145Hz to reduce mains induced noise (fans).

Microphone Filter

Applies a high-pass filter to the microphone input. Used to reduce audio artifacts like humming or buzzing by filtering out unwanted frequencies.

Microphone Noise Filter

Enables heavy filtering below 145Hz to reduce mains induced noise (fans).

Advanced Settings Tab – Advanced SIP

Status	Basic Settings	Additional Features	Advanced Settings	System	Logout	
Network	Admin	Time	Provisioning	Advanced Audio	Advanced SIP	Advanced Multicast

Advanced SIP Settings

General

SIP Transportation:

- Select Auto to check DNS NAPTR record, then try UDP/TCP.
- In TLS mode, if the SIP Server requires endpoints to be authenticated, a PEM file containing both a device certificate and a private key needs to be installed on the Algo device. Use the "System > File Manager" tab to upload a certificate file renamed to 'sipclient.pem' in the 'certs' folder.

SIPS Scheme: Enabled Disabled

Validate Server Certificate: Enabled Disabled

- Validate the SIP server against common certificate authorities. To validate against additional certificates, use the "System > File Manager" tab to upload a Base64 encoded X.509 certificate file in .pem, .cer, or .crt format to the 'certs/trusted' folder.

Force Secure TLS Version: Enabled Disabled

- Enable this option to require TLS connections to use TLSv1.2.

SIP Outbound Support (RFC 5626): Enabled Disabled

- Enable this option to support best networking practices according to RFC 5626. This option should generally be enabled if the Algo device is being registered with a hosted server or if TLS is being used for SIP Transportation.

Outbound Proxy:

Register Period (seconds):

SRTP

SDP SRTP Offer:

NAT

Media NAT: None ICE STUN

TURN Server:

TURN User:

TURN Password: 

SIP Transportation

Which transport layer protocol to use for SIP messages. Setting 'SIP Transportation' to 'TLS', ensures the encryption of SIP traffic.

SIPS Scheme

Only visible when 'SIP Transportation' set to 'TLS'. Enabling SIPS Scheme requires the SIP connection from endpoint to endpoint to be secure.

SDP SRTP Offer

Setting 'SDP SRTP Offer' to 'Optional', means the SIP call's RTP data will be left unencrypted if the other party does not support SRTP. Setting 'SDP SRTP Offer' to 'Standard', encrypts RTP voice data, meaning the normal audio RTP packets will now be secure (SRTP). This means SIP calls will be rejected if other party does not support SRTP. The 'Standard' option secures the audio data between parties, by making sure that it's not left out in the open for third parties to later reconstruct and listen to.

SIP Outbound Support (RFC 5626)

Enable this option to support best networking practices according to RFC 5626. This option should generally be enabled if the Algo device is being registered with a hosted server or if TLS is being used for SIP Transportation.

Outbound Proxy

IP address for outbound proxy. A proxy (server) stands between a private network and the internet.

Register Period (seconds)

Maximum requested period of time where the 8198 will re-register with the SIP server. Default setting is 3600 seconds (1 hour). Only change if instructed otherwise.

Media NAT

IP address for STUN server if present or IP address/credentials for a TURN server.

Server Redundancy

Server Redundancy Feature (Multiple SIP Server Support)	<input checked="" type="radio"/> Enabled <input type="radio"/> Disabled
Backup Server #1	<input style="width: 100%;" type="text"/>
Backup Server #2	<input style="width: 100%;" type="text"/>
Polling Interval (seconds)	<input type="text" value="120 seconds (2 minutes)"/> <small>i Time to wait between sending monitoring packets to each server. Inactive servers are always polled and the active server may optionally be polled (see below).</small>
Poll Active Server	<input type="radio"/> Enabled <input checked="" type="radio"/> Disabled <small>i Explicitly poll the current server to monitor its availability. Polling may also be handled automatically by other regular events, so this can be disabled to reduce network traffic.</small>
Automatic Failback	<input checked="" type="radio"/> Enabled <input type="radio"/> Disabled <small>i Reconnect with a higher priority server once available, even if the backup connection is still working.</small>
Polling Method	<input checked="" type="radio"/> SIP NOTIFY <input type="radio"/> SIP OPTIONS <small>i SIP message used to poll servers in order to monitor their availability.</small>

Interoperability

Keep-Alive Method	<input checked="" type="radio"/> None <input type="radio"/> Double CRLF <small>i This setting will enable sending periodic CRLF messages for both UDP and TCP connections.</small>
Use Outgoing TLS port in SIP headers	<input checked="" type="radio"/> Enabled <input type="radio"/> Disabled <small>i Use ephemeral port number from outgoing SIP TLS connection instead of listening port number in SIP Contact and Via headers. This is useful to connect the device to some local SIP servers, like Asterisk or FreeSWITCH.</small>
Do Not Reuse Authorization Headers	<input type="radio"/> Enabled <input checked="" type="radio"/> Disabled <small>i When enabled, all SIP authorization information from the last successful request will not be reused in the next request.</small>
Allow Missing Subscription-State Headers	<input type="radio"/> Enabled <input checked="" type="radio"/> Disabled <small>i When enabled, allow SIP NOTIFY messages that do not contain a "Subscription-State" header.</small>

Save

Server Redundancy Feature

Two secondary SIP servers may be configured. The 8198 will attempt to register with the primary server but switch to a secondary server when necessary. The configuration allows re-registration to the primary server upon availability or to stay with a server until unresponsive.

If Server Redundancy is selected the web page will expand as shown below.

Backup Server #1

If the primary server is unreachable the 8198 will attempt to register with the backup servers. If enabled, the 8198 will always attempt to register with the highest priority server.

Backup Server #2

If backup server #1 is unreachable the 8198 will attempt to register with the 2nd backup server. If enabled, the 8198 will always attempt to register with the highest priority server.

Polling Intervals (seconds)

Time period between sending monitoring packets to each server. Non-active servers are always polled, and active server may optionally be polled (see below).

Poll Active Server

Explicitly poll current server to monitor availability. May also be handled automatically by other regular events, so can be disabled to reduce network traffic.

Automatic Fallback

Reconnect with higher priority server once available, even if backup connection is still fine.

Polling Method

SIP message used to poll servers to monitor availability.

Keep-alive Method

If Double CRLF is selected the 8198 will send a packet every 30 seconds (recommended value) to maintain connection with the SIP Server if behind NAT.

Keep-alive Interval

Interval in seconds that the CRLF message should be sent.

Use Outgoing TLS port in SIP headers

Use ephemeral port number from outgoing SIP TLS connection instead of listening port number in SIP Contact and Via headers. This is useful to connect the device to some local SIP servers, like Asterisk or FreeSWITCH.

Do Not Reuse Authorization Headers

When enabled, all SIP authorization information from the last successful request will not be reused in the next request.

Allow Missing Subscription-State Headers

When enabled, allow SIP NOTIFY messages that do not contain a "Subscription-State" header.

Advanced Settings Tab – Advanced Multicast

Status
Basic Settings
Additional Features
Advanced Settings
System
Logout

Network
Admin
Time
Provisioning
Advanced Audio
Advanced SIP
Advanced Multicast

Advanced Multicast Settings

i Current multicast mode: Master
Multicast mode can be set in "Basic Settings > Multicast"

Master Settings

Master Output Codec: G.711 ulaw

Output Packetization Time (milliseconds): 20

RTP Control Protocol (RTCP)

RTCP Port Selection

Disabled
 Next Higher Port
 Multiplexed on Same Port

i Select the port on which packets will be sent or received.
If using the 'Next Higher Port' option, ensure that the default multicast zone definitions are modified such that zones are only assigned to even-numbered ports, leaving the next higher odd-numbered ports free for RTCP packets.

Basic Zone Definition

Zone	IP Address and Port	Page Tone
Priority Call (DTMF:9)	224.0.2.60:50000	<Use Default Page Tone>
All Call (DTMF:0/8)	224.0.2.60:50001	<Use Default Page Tone>
Zone 1 (DTMF:1)	224.0.2.60:50002	<Use Default Page Tone>
Zone 2 (DTMF:2)	224.0.2.60:50003	<Use Default Page Tone>
Zone 3 (DTMF:3)	224.0.2.60:50004	<Use Default Page Tone>
Zone 4 (DTMF:4)	224.0.2.60:50005	<Use Default Page Tone>
Zone 5 (DTMF:5)	224.0.2.60:50006	<Use Default Page Tone>
Zone 6 (DTMF:6)	224.0.2.60:50007	<Use Default Page Tone>
Music (DTMF:7)	224.0.2.60:50008	<Use Default Page Tone>

Expanded Zone Definition

Zone	IP Address and Port	Page Tone
Zone 10 (DTMF: *10)	224.0.2.110:50000	<Use Default Page Tone>
Zone 11 (DTMF: *11)	224.0.2.111:50000	<Use Default Page Tone>

Note: The settings on this tab are only visible when in master or slave multicast mode.

The default prepopulated multicast addresses above will work in most cases and should only be altered for rare cases.

Audio Sync (Slave Mode)

When using multicast with other third-party devices that have a delay in their audio path, the audio on the 8198 may be heard slightly earlier than on these other devices. By adding audio delay up to one second, the 8198 may be synchronized with other speakers or telephones that have greater latency. This feature applies to Multicast Slave mode only.

Master Output Codec (Master Mode)

Audio encoding format used by the Master device when sending output to the slaves.

Master Output Packetization Time (Master Mode)

The size of the audio packets sent by the Master to the Slaves. The default of 20ms is recommended, unless a different value is specifically required for compatibility with other devices.

RTCP Port Selection

Select the port on which RTCP packets will be sent or received. If using the 'Next Higher Port' option, ensure that the default multicast zone definitions are modified such that zones are only assigned to even-numbered ports, leaving the next higher odd-numbered ports free for RTCP packets.

Zone Definition

The "Expanded" Slave zones can be enabled/disabled in Basic Settings > Multicast. Default IP addresses and ports may be revised for any given zone in the table.



Important: Ensure that the Address and Port settings are the same for all master and slave devices.

Page Tone and Page Volume

Master Mode: By default, the same tone can be set for all Slave zones in the Basic Settings > Features tab. Unique paging tones may be revised for any given slave zone in the table above.

Slave Mode: When an Algo device is the multicast Master, a page tone will play on the Slave device, so it is recommended to set the Slave tone to "None". If a page is received from a non-Algo device that doesn't send a tone, a tone can be inserted on the Slaves (above) each time they detect page audio starting, allowing them to play a tone.

By default, the same page volume can be set for all Slave zones in the Basic Settings > Features tab. Unique page volumes may be revised on a per-zone basis in the table above. For instance, emergency pages can be louder on certain Slave speakers.

Polycom Slave Tones

Available if Multicast Slave and "Polycom Group Page" or "Polycom Push-to-Talk" are selected in the Basic Settings > Multicast tab. A tone may be set for any of the 25 Polycom Groups. If using an Algo device as a Multicast master, it is recommended to set the slave tones to "None" to avoid conflicts, as the Algo devices already multicast a tone by default.

Web Interface System

System Tab - Maintenance

Download Configuration File

Save the device settings to a text file for backup or to setup a provisioning configuration file.

Restore Configuration File

Restore settings from a backup file.

Restore Configuration to Defaults

Resets all 8198 Paging Adapter & Scheduler device settings to factory default values.

Download Backup File

Saves the device settings (configuration) and all the files in File Manager: certificates, licenses, and tones to a backup zip file.

Restore from Backup Zip File

Restores the device settings (configuration) and all the files in File Manager: certificates, licenses, and tones from a backup zip file

Restore All Settings and Files to Defaults

Resets the device settings (configuration) and all the files in File Manager: certificates, licenses, and tones to factory default values.

Reboot the Device

Reboots the device.

System Tab - Firmware

Status
Basic Settings
Additional Features
Advanced Settings
System
Logout

Maintenance
Firmware
File Manager
Tones
System Log
Credits
About

Firmware

Installed Firmware

Product Firmware	algo-8186-3.2.1
Base Firmware (Linux Kernel and Boot Utilities)	algo-pb-base-3.2
System Firmware (Debian System Packages)	algo-pb-sys-3.2

Online Upgrade

Check for Firmware Updates Check

Custom Upgrade

Method From Local Files From URL

Signed Firmware File Browse... No file selected.

Allow Downgrade Enabled Disabled

i Allow product or base firmware to be downgraded to an older version.
! Enabling this option could cause upgrade issues. Please contact support if necessary.

Upgrade

Method

For firmware upgrades. Specify whether the firmware files will be downloaded from the local computer or a remote URL.

Signed Firmware Image

Point to the SFW file provided by Algo.

How to upgrade the 8198 SIP Ceiling Speaker Firmware

1. From the top menu, click on System, then Maintenance.
2. In the Upgrade section, click on Choose File and select the 8198 firmware file to upload. Note that a SFW file must be loaded.
3. Click Upgrade
4. After the upgrade is complete, confirm that the firmware version has changed (refer to top right of Control Panel).

System Tab – File Manager

Name	Date	Type	Size
certs	11/03/2016 10:16 AM	Folder	
debug	02/03/2020 02:46 PM	Folder	
license	06/04/2019 01:00 PM	Folder	
tones	12/31/1999 04:02 PM	Folder	
user.conf	05/14/2020 09:20 PM	Text File	11.182KB

Files must be uploaded on to the designated folder, unless the 8198 will not recognize the file. For TLS provisioning and SIP signaling, a certificate file must be uploaded on to the 'certs' folder. Where as Informacast license has to be uploaded on to the 'license' folder. The 'tones' folder will be pre-loaded with audio files, more audio files maybe uploaded.

Uploading Custom Audio Files

Custom audio files (WAV or mp3) may be uploaded into memory (1 GB) to play for notification applications. Place your audio files into the **tones** directory.

An existing file may also be modified by downloading the original by right clicking the tone and selecting 'Download', making the desired changes, and then uploading the new version with a different name. Audio files must be in the following format:

- WAV or MP3 format
- 16-bit PCM, or u-law
- Mono
- Smaller than 200MB

File names must be limited to 32 characters, with no spaces.

Tone Files Included in Memory

The 8198 SIP Ceiling Speaker PoE+ includes several pre-loaded audio files that can be selected to play for various events. The web interface allows selection of the audio file and also the ability to play the audio file immediately over the speaker for testing. Files may also be deleted or renamed.

Certificates

The user certificate file named 'sipclient' with '.pem', '.crt', or '.cer' file type extension must be uploaded to 'certs' folder. For the trusted certificate, it should be name 'siptrusted' with '.pem', '.crt', or '.cer' file type extension must be uploaded to the 'trusted' folder inside the 'certs' folder.

License

To use informacast, the license file must be uploaded to the 'license' folder.

Contact Algo for more information.

System Tab – Tones

Status Basic Settings Additional Features Advanced Settings **System** Logout

Maintenance Firmware File Manager **Tones** System Log Credits About

Tones

Use the "System > [File Manager](#)" tab to upload tone files to "tones" subdirectory.

Files

Download and Install Ring Tones from the Algo Server

Tone files can be downloaded manually from [the Algo website](#).

Cache

Rebuild Tone Cache Files

Only needed when the tone cache is out of sync. The operation might take a long time depending on the types and sizes of the tone files.

Test Tones

This tab can be used to download/install/rebuild the audio files Algo provides. To ensure that the audio files has been succesfully installed, used 'Test Tones' options to test the chosen tones.

System Tab – System Log

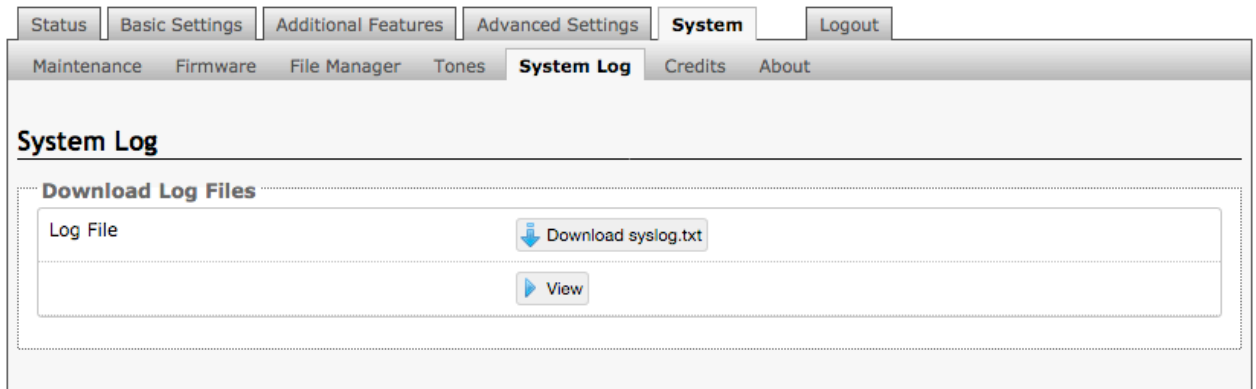

System log files are automatically created and assist with troubleshooting in the event the 8198 SIP Ceiling Speaker PoE+ does not behave as expected.

Specifications

Power Input:	Type 2 PoE+ IEEE 802.3at (Max 25.5.W)
Dimensions:	8" (20.5cm) diameter without trim ring 9.8" (24.9cm) with trim ring, Total height 6.9" (17.5cm) Blind mounts into 8" hole. Clearance requirement of 5.5" (14.0cm) above ½" (1.27cm) gypsum board ceiling
Mounting:	Ceiling Mounting
Weight:	4.5 lb (2 kg)
SIP:	Multiple extensions for Page or Alerting
Multicast:	Receive or transmit
Audio Codecs:	G.711 A-law, G.711 u-law, G.722, Polycom Group Page
Audio Delay:	1 to 1000 ms selectable for synchronization
Audio Memory:	1 GByte available
Speech Processing:	ALC, filtering, compression
Relay Input:	Normally open or normally closed dry contact supervision. Algo 1202 CallBox, Algo 1203 Wall Switch, EOL termination

Relay Input Current
Draw Detection
Thresholds:

	Active	Idle	Tamper
Normally Open	>4mA	<4mA	N/A
Normally Open with Supervision	>20mA	4-20mA	<4mA
Normally Closed	<4mA	>4mA	N/A
Normally Closed with supervision	4-20mA	>20mA	<4mA

Nominal 12V source, current limited to 40mA

Typical supervision resistor value = 1kOhm

Configuration:	Web interface or provisioning
Provisioning:	TFTP, FTP, HTTP, HTTPS
Supervision:	SNMP
NAT:	STUN, CRLF Keep Alive
Processor:	Linux OS ARM Cortex-A8 32-Bit RISC Processor
Server Redundancy:	Primary, secondary, tertiary
Environmental:	+32 to +104 °F (0 to + 40 °C); Dry indoor locations only
Compliance:	RoHS, CE, FCC Class A, CSA/UL (USA & Canada)

FCC Compliance Statement

This equipment has been tested and found to comply with the limits for a Class A digital device, pursuant to Part 15 of the FCC Rules. These limits are designed to provide reasonable protection against harmful interference when the equipment is operated in a commercial environment. This equipment generates, uses, and can radiate radio frequency energy, and if it is not installed and used in accordance with the instruction manual, it may cause harmful interference to radio communications. Operation of this equipment in a residential area is likely to cause harmful interference, in which case the user will be required to correct the interference at his own expense.