

8373 Zone Paging Adapter FW Version 1.7

User Guide



Order Codes

8373

Zone Paging Adapter

Table of Contents

IMPORTANT SAFETY INFORMATION	4
OVERVIEW	6
INTRODUCTION	6
TYPICAL APPLICATIONS	7
SETUP AND INSTALLATION	8
GETTING STARTED - QUICK INSTALL & TEST	8
INSTALLATION	9
PROGRAMMING AND CONFIGURATION	9
FEATURES	10
SIP PAGING: INTRODUCTION	10
SIP PAGING: SINGLE SIP EXTENSION	11
SIP PAGING: MULTIPLE SIP EXTENSIONS	11
SIP PAGING: 9 ZONES USING ONE AMPLIFIER	12
SIP PAGING: USING MULTICAST	13
MULTICAST PAGE ZONES	13
POLYCOM™ GROUP PAGING	14
TLS FOR SIP SIGNALING AND PROVISIONING	15
WIRING CONNECTIONS	18
BLUE LED INDICATORS	20
RESET	20
WEB INTERFACE STATUS AND LOGIN	21
WEB INTERFACE LOGIN	21
STATUS	22
WEB INTERFACE BASIC SETTINGS	23
BASIC SETTINGS TAB – SIP	23
BASIC SETTINGS TAB – FEATURES	24
BASIC SETTINGS TAB – CHANNELS	26
BASIC SETTINGS TAB - MULTICAST (MASTER SETTINGS)	26
BASIC SETTINGS TAB - MULTICAST (MASTER SETTINGS)	28
BASIC SETTINGS TAB - MULTICAST (SLAVE SETTINGS)	29
WEB INTERFACE ADDITIONAL FEATURES	30
ADDITIONAL FEATURES TAB – MORE PAGE EXTENSIONS	30
WEB INTERFACE ADVANCED SETTINGS	31
ADVANCED SETTINGS TAB - NETWORK	31
ADVANCED SETTINGS TAB – ADMIN	33
ADVANCED SETTINGS TAB – TIME	35
ADVANCED SETTINGS TAB – PROVISIONING	36
ADVANCED SETTINGS TAB – FILE MANAGER	38
ADVANCED SETTINGS TAB – ADVANCED AUDIO	39
ADVANCED SETTINGS TAB – ADVANCED SIP	40
ADVANCED SETTINGS TAB – ADVANCED MULTICAST	43

WEB INTERFACE SYSTEM	45
SYSTEM TAB – MAINTENANCE	45
SYSTEM TAB – SYSTEM LOG	46
SPECIFICATIONS	47
FCC COMPLIANCE STATEMENT.....	48

Important Safety Information

Important Safety Information

This product is powered by a certified limited power source (LPS), Power over Ethernet (PoE); through CAT5 or CAT6 connection wiring to an IEEE 802.3af compliant network PoE switch. The product is intended for installation indoors. All wiring connections to the product must be in the same building. If the product is installed beyond the building perimeter or used in an inter-building application, the wiring connections must be protected against overvoltage / transient. Algo recommends that this product be installed by a qualified electrician.

If you are unable to understand the English language safety information then please contact Algo by email for assistance before attempting an installation support@algosolutions.com.

Consignes de Sécurité Importantes

Ce produit est alimenté par une source d'alimentation limitée certifiée (alimentation par Ethernet); des câbles de catégorie 5 et 6 joignent un commutateur réseau à alimentation par Ethernet homologué IEEE 802.3af. Le produit est conçu pour être installé à l'intérieur. Tout le câblage rattaché au produit doit se trouver dans le même édifice. Si le produit est installé au-delà du périmètre de l'édifice ou utilisé pour plusieurs édifices, le câblage doit être protégé des surtensions transitoires. Algo recommande qu'un électricien qualifié se charge de l'installation de ce produit.

Si vous ne pouvez comprendre les consignes de sécurité en anglais, veuillez communiquer avec Algo par courriel avant d'entreprendre l'installation au support@algosolutions.com.

Información de Seguridad Importante

Este producto funciona con una fuente de alimentación limitada (Limited Power Source, LPS) certificada, Alimentación a través de Ethernet (Power over Ethernet, PoE); mediante un cable de conexión CAT5 o CAT6 a un conmutador de red con PoE en cumplimiento con IEEE 802.3af. El producto se debe instalar en lugares cerrados. Todas las conexiones cableadas al producto deben estar en el mismo edificio. Si el producto se instala fuera del perímetro del edificio o se utiliza en una aplicación en varios edificios, las conexiones cableadas se deben proteger contra sobretensión o corriente transitoria. Algo recomienda que la instalación de este producto la realice un electricista calificado.

Si usted no puede comprender la información de seguridad en inglés, comuníquese con Algo por correo electrónico para obtener asistencia antes de intentar instalarlo: support@algosolutions.com.

Wichtige Sicherheitsinformationen

Dieses Produkt wird durch eine zertifizierte Stromquelle mit begrenzter Leistung (LPS – Limited Power Source) betrieben. Die Stromversorgung erfolgt über Ethernet (PoE – Power over Ethernet). Dies geschieht durch eine Cat-5-Verbindung oder eine Cat-6-Verbindung zu einer IEEE 802.3af-konformen Ethernet-Netzwerkweiche. Das Produkt wurde konzipiert für die Installation innerhalb eines Gebäudes. Alle Kabelverbindungen zum Produkt müssen im selben Gebäude bestehen. Wenn das Produkt jenseits des Gebäudes oder für mehrere Gebäude genutzt wird, müssen die Kabelverbindungen vor Überspannung und Spannungssprüngen geschützt werden. Algo empfiehlt das Produkt von einem qualifizierten Elektriker installieren zu lassen.

Sollten Sie die englischen Sicherheitsinformationen nicht verstehen, kontaktieren Sie bitte Algo per Email bevor Sie mit der Installation beginnen, um Unterstützung zu erhalten. Algo kann unter der folgenden E-Mail-Adresse erreicht werden:
support@algosolutions.com.

安全须知

本产品由认证的受限电源（LPS），以太网供电（PoE），通过 CAT5 或 CAT6 线路联接至 IEEE 802.3at PoE+ or 802.3af 兼容的 PoE 网络交换机供电。本产品适用于室内或建筑物周边安装。所有联接本产品的线路必须源自同一建筑物。本产品如需用于超出建筑物周边范围或跨建筑物的安装，线路联接部分必须有过压和瞬态保护。Algo 建议本产品由专业电工安装。

如果您对理解英文版安全须知有问题，安装前请通过电子邮件和 Algo 联系，support@algosolutions.com。

EMERGENCY COMMUNICATION

If used in an emergency communication application, the 8373 Zone Paging Adapter should be routinely tested. SNMP supervision is recommended for assurance of proper operation. Contact Algo for other methods of operational assurance.

WET OR OUTDOOR ENVIRONMENTS

The 8373 Zone Paging Adapter is intended for dry indoor locations only. For outdoor locations Algo offers weatherproof speakers and strobe lights.

CAT5 or CAT6 connection wiring to an IEEE 802.3af compliant network PoE switch must not leave the building perimeter without adequate lightning protection.

No wiring connected to the 8373 Zone Paging Adapter may leave the building perimeter without adequate lightning protection.

Overview

Introduction

The 8373 Zone Paging Adapter creates multiple paging zones, while interfacing between the SIP-enabled phone system and the traditional paging amplifier. When answering an inbound call, the 8373 can route the call's audio to the amplifier, via an analog connector. One amplified audio stream can then be fed back into the 8373 and sent to one or more of the three speaker Channels at a time. It is important to note that the 8373 doesn't allow **different** audio streams to play on two Channels simultaneously as it is designed to interface with a single amplifier. To interface with multiple amplifiers, we recommend using multiple Algo 8301 Paging Adapters instead.

The 8373 can register as a voice paging SIP extension with a hosted or enterprise Communications Server supporting 3rd party SIP endpoints. Multiple SIP paging extensions may also be registered on the 8373, one for each zone in use.

Multicasting capabilities allow a SIP registered 8373 to page and simultaneously stream multicast audio to other Algo devices. Only one 8373 is required to register as a SIP extension when using multiple adapters in a SIP environment.

Connection to the amplifier is made using a balanced and isolated line level output provided as either an XLR-mini connection (front) or pluggable terminal block for twisted pair wiring (back). The audio level can be adjusted manually or set to a defined level independent of input.

The 8373 Zone Paging Adapter is configured using central provisioning features or by accessing a web interface using browsers such as Chrome, Firefox, or Edge.

What is Included

- 8373 Zone Paging Adapter
- Network Cable
- Wall Mount Bracket and screws
- Five pluggable terminal block for relay input and output
- Terminal block cover
- Flat head screwdriver
- Getting Started Sheet

What is not Included

- Optional 2504 Output XLR-Mini Female to Male
- This Installation Guide (www.algosolutions.com/8373/guide)

Typical Applications

The 8373 Zone Paging Adapter is typically used to connect an existing paging amplifier to a UC environment either as a SIP extension or multicast endpoint. The 8373 can relay the single unique audio stream from the amplifier to one of the 3 speaker channels, creating a “zoned” paging system. Two or all three channels may be activated simultaneously to page all speakers.

The 8373 will replace a legacy zone controller or create page zones from a previously single zoned analog amplifier. It creates a hybrid voice paging solution to integrate analog speaker infrastructure and multicast to Algo IP speakers, strobe lights and paging adapters, in addition to multicast supported IP telephones.

The Line Output of the 8373 is connected directly to the dry audio input on the amplifier with an input impedance between 600 Ohm and 10 kOhm.

For amplifiers connected directly to the dry page port of an existing telephone system, the 8373 will provide a very similar interface providing both dry page audio and dry contact closure to activate the amplifier (if required).

For amplifiers connected to a FXS port or ATA through a “telephone answering device”, the 8373 will replace the answering device and eliminate the need for a FXS port or ATA. Please note the 8373 does not provide a FXS port interface.

Setup and Installation

Getting Started - Quick Install & Test



This guide provides important safety information which should be read thoroughly before permanently installing the adapter.

1. Connect the 8373 Zone Paging Adapter to an IEEE 802.3af compliant PoE network switch or PoE injector. The blue lights on the front will remain on until boot up is completed – about 30 seconds.
2. After the blue lights turn off, press the reset switch (RST) to hear the IP address over the Line Out port. The IP address may also be discovered by downloading the Algo locator tool to find Algo devices on your network: www.algosolutions.com/locator
3. Connect the adapter Line Out to an input amplifier using the mini-XLR connector (front) or pluggable terminal block (back).
4. Connect the output of the amplifier to the Amp In terminals.
5. Connect each speaker run to Channel 1, 2 or 3.
6. Access the 8373 Zone Paging Adapter web page by entering the IP address into a browser (e.g. Chrome, Firefox or Edge) and login using the default password **algo**.
7. Enter the IP address or the name for the SIP server into the SIP Domain field under the **BASIC SETTINGS > SIP** tab.
8. Enter the SIP Extension, Authentication ID, and Password.
Note: The Authentication ID may also be called Username for some SIP servers, and in some cases may be the same as the SIP extension.
9. Verify the extension is properly registered with the SIP server in the Status tab. Ensure the SIP Registration is “Successful”.
10. Make a call to the adapter by dialling its extension from a telephone. A prompt tone will be heard when the 8373 answers – press “1” to call zone 1, which will activate the relay for Channel 1 based on the default settings.

Installation

The 8373 is wall mountable in a horizontal orientation using the supplied bracket.



Example installation on 1/2" drywall:

Use appropriate drywall anchors for #8 screws, and pre-drill per anchor manufacturer's instructions. Insert 4 anchors into the wall, and then attach bracket to wall anchors using #8 screws. Snap the 8373 into the bracket.

Connect the 8373 to a PoE network switch.

Connect the audio output of the 8373 to an amplifier input using either the mini-XLR output (male pins) or pluggable terminal block. The 8373 provides a dry audio output and dry contact closure.

An optional XLR output audio cable (Algo 2504) may be ordered for audio amplifiers using standard XLR input connectors.

Programming and Configuration

The 8373 Zone Paging Adapter is configurable using the web interface or provisioning features.

After boot up the blue lights on the front will turn off and the adapter will have obtained an IP address. If there is no DHCP server the 8373 Zone Paging Adapter will default to the static IP address **192.168.1.111**.

The IP address can be heard over the Line Out port when the reset switch (RST) is pressed. (Do not press this button during boot-up as it will cause the device to reset to factory defaults). The IP address may be discovered by downloading the Algo locator tool to find Algo devices on your network: www.algosolutions.com/locator

Enter the IP address (e.g. 192.168.1.111) into a browser such as Google Chrome, Firefox, or Edge. The web interface should be visible and the default password will be **algo** in lower case letters.

Features

SIP Paging: Introduction

The 8373 has only one audio output, and therefore can only support a single unique audio stream at any given time. This is ideal when connecting to a single zone amplifier that also only supports a single audio path at a time. The Channel relays then allow the speakers to be broken off into groups, creating a “zoned” paging system.

The 8373 can be registered as one or more SIP extensions with the SIP phone system, and will auto-answer inbound calls to these extensions, play a pre-announce tone, and allow voice paging until disconnected.

The simplest scenario is to configure the 8373 with a single SIP extension on the phone system, and then use the DTMF keys on the phone to select the zone that you would like to page. An alternate approach is to register multiple SIP extensions, one for each zone that you wish to use, so that each can be dialed directly without the need for the user to remember the different DTMF zone numbers. Both of these scenarios are described in more detail in the examples below.

If a VLAN is used on your network, navigate to the **Advanced Settings > Network** tab to set VLAN options.

(Note, once the adapter is using VLAN you will need to be on the same VLAN to access the web interface.)

There are a number of configurable adapter options:

- Increase or decrease speaker volume
- Enable AGC (automatic gain control)
- Customize pre-announce tone file

The best voice paging quality and intelligibility will be obtained using the G.722 wideband audio codec. Most current IP telephones support G.722 which is sometimes referred to as “HD” voice or audio.

SIP Paging: Single SIP Extension

Up to 50 zones can be assigned on each of the three 8373 Channels. The 8373 will auto-answer an inbound call to the SIP extension, e.g. 1000, and a brief tone will prompt the caller to dial a DTMF key to select the desired zone. For example, if zone 2 is assigned to Channel 2, dialing “2” will activate Channel 2 and provide audio to speakers connected to this channel. If zone 2 is associated with channels 2 and 3, dialing “2” will activate both channels and play the audio on the speakers associated with these 2 channels.

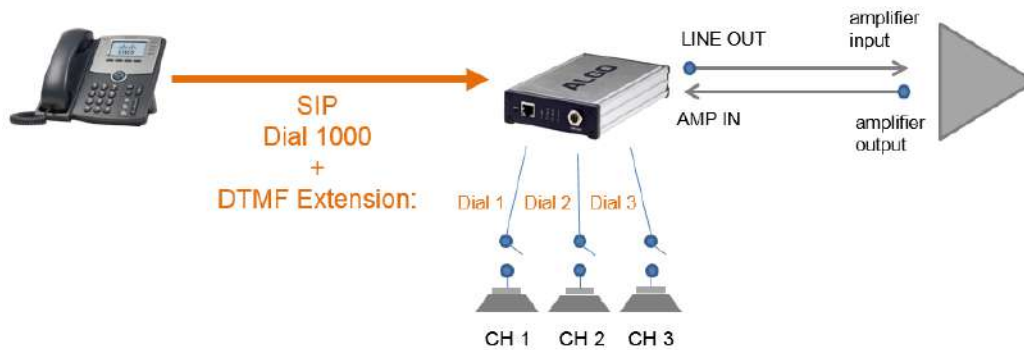

Note: DTMF codes for zones 10 and higher start with an “*”.

To register the adapter with a single SIP extension, use the **Basic Settings > SIP** tab in the web interface to enter the SIP Server IP address, extension, username, and password. This information will be available from the IT Administrator or telephone service provider.

Specific zones can be assigned to Channels by going to the **Basic Settings > Channels** tab.

SIP Paging: Multiple SIP Extensions

Multiple SIP extensions can also be registered on the 8373, one for each zone in use, using the tab: **Additional Features > More Page Extensions**. This allows the advantage of dialing directly to a zone without needing to enter DMTF, allowing the use of speed-dial keys. Additional SIP licenses may be required by the SIP provider.

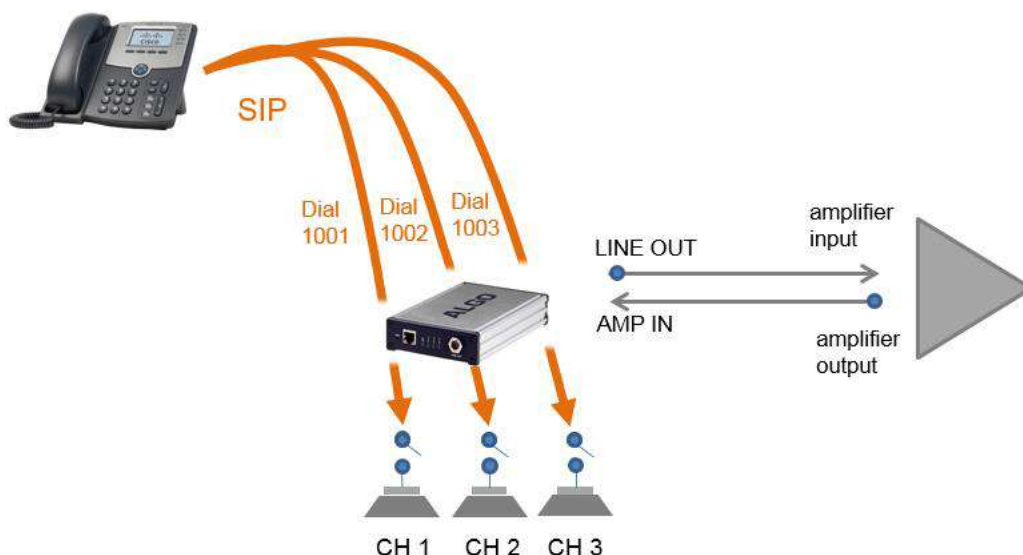

SIP Paging: 9 Zones using One Amplifier

To create more than 3 zones, additional 8373's may be connected to the single amplifier via the AMP IN on the back of each of the 8373's. The first 8373 should be assigned as a Multicast Master, and the remainder as Slaves. Each Slave relay channel can then be independently assigned to different paging zones. Dialing the Multicast Master can now activate up to 9 Channels, and play the audio on all associated speakers.

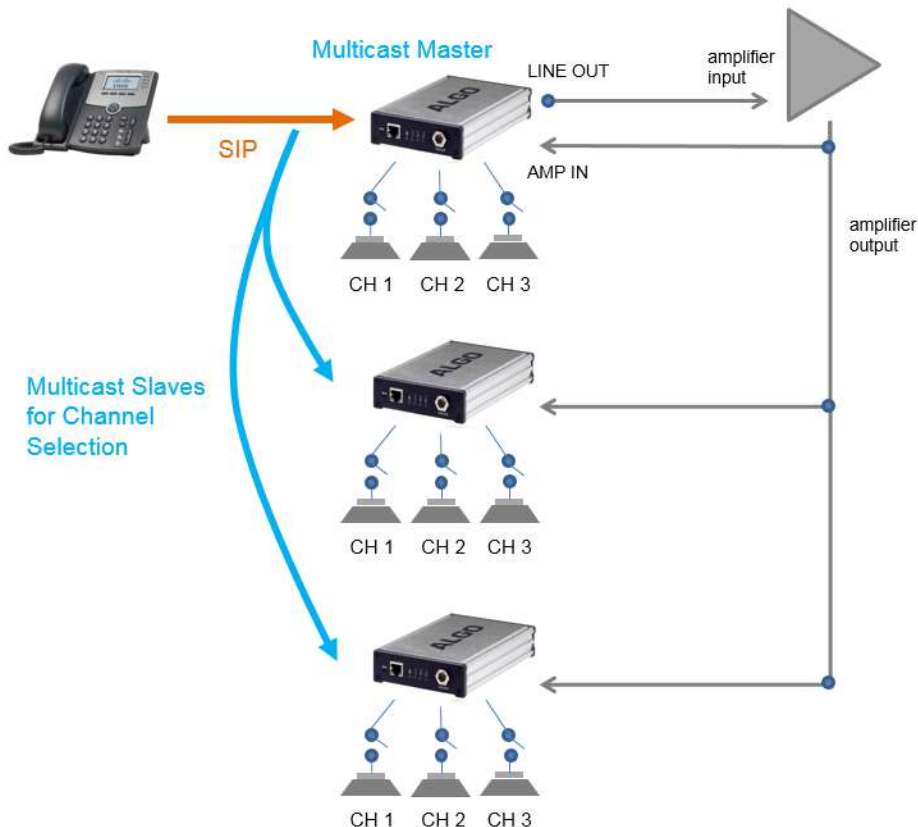

Note: When using slave 8373's in this configuration of multicast combined with a single amplifier driving the slave 8373's, the system must be designed with only a single master device in order to ensure that the audio being received from the amp matches the multicast control signals seen at each slave.

Up to 50 zones can be configured. The first nine “basic” zones are available by default. Additional “expanded” zones can also be enabled in the **Basic Settings > Multicast** tab. If the amplifier already supports three zones, and you wish to use all three simultaneously, then three Algo 8301 Paging Adapters might be the tool for the job instead.

Any combination of Algo SIP endpoints can be integrated using multicast, or kept independent by registering additional SIP extensions on each. For instance, in addition to a single 8373 driving an amplifier and creating 3 speaker zones, any number of 8188 Ceiling Speakers can also be added as Multicast Slaves, and automatically play the same audio as was sent to the amplifier & speakers.

SIP Paging: Using Multicast

Multicast can be used to integrate the 8373 with other Algo SIP Endpoints to create a fully-integrated Paging solution.

Only the Multicast Master device is required to register as a SIP extension when using multiple Algo devices in a SIP environment. Thus, the slave adapters do not require SIP extensions and do not need to register with the SIP Communication Server.

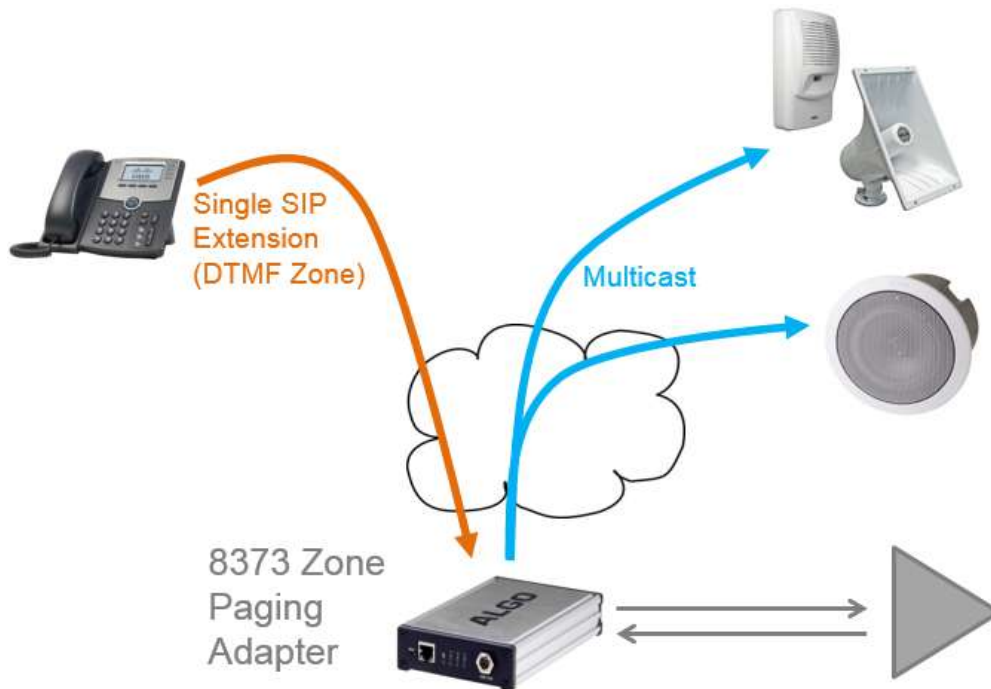

Each of the 3 relay channels on the 8373 can be assigned to any zone, or group of zones, as described in the other examples above, and likewise, each of the other Algo SIP endpoints can be assigned to one or more zones. Any one of the devices can be the Master, and the rest can be configured as Slaves. As usual, either a single SIP extension (with DTMF selectable zone), or multiple SIP extensions (one per zone) can be configured on the Master, depending on the preference of the end user.

Multicast Page Zones

The 8373 Zone Paging Adapter supports nine “basic” multicast zones. These zones are defined by the multicast IP addresses.

Somewhat arbitrarily, these zones are defined below but may be used in other ways. The important consideration is that there is a priority hierarchy – streaming activity on a zone higher on the list will be treated as a higher priority than a zone lower on the list – with music being the lowest priority.

- Priority
- All Call
- Zone 1
- Zone 2

- Zone 3
- Zone 4
- Zone 5
- Zone 6
- Music

“Expanded” zones can also be enabled, allowing up to 50 zones in total. These have the same behaviours as the basic zones, but are hidden by default to simplify the interface.

Note: DTMF codes for zones 10 and higher start with an “*”.

Polycom™ Group Paging

The 8373 Zone Paging Adapter has been designed to support Polycom Group Paging.

The 8373 Zone Paging Adapter can be added to a Polycom group page so that voice paging is heard over Polycom telephone speakers and overhead paging simultaneously.

Polycom Group Paging can be configured on the **Basic Settings > Multicast** tab.



The 8373 Zone Paging Adapter may be accessed remotely via SIP and may generate a multicast page within the LAN sending voice page to both Algo paging endpoints and Polycom telephones. Audio delay may be added to the 8373 Zone Paging Adapter to synchronize with voice page over the Polycom telephone speakers.

TLS for SIP Signaling and Provisioning

Algo devices that support firmware 1.6.4 or later support Transport Layer Security (TLS). This feature adds security by ensuring that Algo products can trust the hosted SIP server. This is useful for when third-party devices or attackers may try to intercept, replicate, or alter Algo products, and try to connect to the server. TLS protocol will ensure that third parties cannot read/modify any actual data. Previously security was less of a concern because phone systems were on isolated networks, but hosted services are becoming increasingly more common. Using a hosted SIP service requires traffic to be sent over the public internet and thus much more susceptible to attacks. Signed certificates are an important piece in the Algo device's operation, to ensure the security, integrity, and privacy of its communication. Algo components that use TLS are **Provisioning** and **SIP Signaling**.

These Algo devices each come pre-loaded with certificates from a list of trusted certificate authorities (CA), which are installed in the hardware at the time of manufacture. Note these pre-installed trusted certificates are not visible to users and are separate from the 'certs' folder.

The TLS handshake happens to make sure that the client and server can trust each other, and once that trust is established, the two parties can freely send encrypted data and decrypt any data that they receive. After the TLS handshake process is complete, a TLS session is established, and the server and client can then exchange messages that are symmetrically encrypted with shared (pre-master) secret key.

For further details reference the [Algo TLS guide for SIP Signalling and HTTPS Provisioning](#).

Uploading Public CA Certificates to Algo SIP Endpoints

To install the public CA certificate on the Algo 8373, follow the steps below:

1. Obtain a public certificate from your Certificate Authority.
2. Rename the public certificate 'siptrusted.pem' (only .pem format is supported).
3. In the web interface of the Algo device, navigate to the **Advanced Settings > File Manager** tab.
4. Upload the certificate files into the 'certs' directory. Click the Upload button in the top left corner of the file manager and browse to the certificate.

For **SIP** TLS, no default public CA certificates are used; only the above .pem file is supported, so this certificate file must be uploaded in order for SIP TLS authentication to occur.

For **Provisioning** TLS, only the default pre-installed public CA certificates are supported; No .pem file can be uploaded in this case.

HTTPS Provisioning

Provisioning can be secured by setting the 'Download Method' to 'HTTPS' (under the **Advanced Settings > Provisioning** tab). This prevents configuration files from being read by an unwanted third-party. This resolves the potential risk of having sensitive data stolen, such as admin passwords and SIP credentials.

The screenshot shows the 'Provisioning Settings' page in a web interface. The page has a navigation bar at the top with tabs for Status, Basic Settings, Additional Features, **Advanced Settings**, System, and Logout. Below this is a sub-navigation bar with tabs for Network, Admin, Time, **Provisioning**, Advanced Audio, Advanced SIP, and Advanced Multicast. The main content area is titled 'Provisioning Settings' and contains several sections:

- Mode:** A section with a label 'Provisioning Mode' and two radio buttons: 'Enabled' (selected) and 'Disabled'.
- Settings:** A section containing several sub-sections:
 - Server Method:** Radio buttons for 'Auto (DHCP Option 66/160/150)', 'DHCP Option 66 only', 'DHCP Option 160 only', 'DHCP Option 150 only', and 'Static' (selected). A help icon and text below state: 'Auto mode automatically checks all 3 DHCP options for an active provisioning server, in the order listed.'
 - Static Server:** A text input field.
 - Download Method:** Radio buttons for 'TFTP', 'FTP', 'HTTP', and 'HTTPS' (selected).
 - Validate Server Certificate:** Radio buttons for 'Enabled' and 'Disabled' (selected). A help icon and text below state: 'Validate the server against common certificate authorities. To validate against additional certificates, use the "System > File Manager" tab to upload a Base64 encoded X.509 certificate file in .pem, .cer, or .crt format to the 'certs/trusted' folder.'
 - Force Secure TLS Version:** Radio buttons for 'Enabled' and 'Disabled' (selected). A help icon and text below state: 'Enable this option to require HTTPS connections to use TLSv1.2.'
 - Auth User Name:** A text input field.
 - Auth Password:** A text input field with a password icon.
 - Config Download Path:** A text input field.
 - Firmware Download Path:** A text input field.



Important: To verify the server 'Enable' the 'Validate Server Certificate' option. This then checks if the certificate that is provided by the server is signed by any of the CAs included in the list of trusted CAs (used by the Debian infrastructure and Mozilla browsers). If we receive a certificate signed by any of these CAs, then that server will be trusted.

The 'Validate Server Certificate' parameter can also be enabled through provisioning:

```
prov.download.cert = 1
```

SIP Signaling (and RTP Audio)

SIP signalling is secured by setting 'SIP Transportation' to 'TLS' (under the **Advanced Settings > Advanced SIP** tab). Setting it to 'TLS' ensures that the SIP traffic will be encrypted. The SIP signalling is responsible for establishing the call (the control signals to start and end the call with the other party), but it does not contain the audio.

For the audio (voice) path, use the setting '**SDP SRTP Offer**'. Setting this to '**Optional**', means the SIP call's RTP audio data will be encrypted (using SRTP) if the other party also supports audio encryption. If the other party does not support SRTP, then the call will still proceed, but with unencrypted audio. In order to make audio encryption mandatory for all calls, set '**SDP SRTP Offer**' to '**Standard**'. In this case, if the other party does not support audio encryption, then the call attempt will be rejected.

The screenshot shows the 'Advanced SIP Settings' page. The 'General' section is expanded, showing the following settings:

- SIP Transportation:** Set to 'TLS'. Below this are two informational notes: one about selecting Auto to check DNS NAPTR records, and another explaining that in TLS mode, a PEM file containing both a device certificate and a private key must be installed in the 'certs' folder, renamed to 'sipclient.pem'.
- SIPS Scheme:** Set to 'Disabled' (radio button selected).
- SDP SRTP Offer:** Set to 'Standard'.
- SIP Outbound Support (RFC 5626):** Set to 'Disabled' (radio button selected). A note below explains that this option should be enabled for hosted servers or if TLS is used for SIP Transportation.
- Outbound Proxy:** An empty text input field.
- Register Period (seconds):** Set to '3600'.



Important: In order for a SIP server to validate the Algo device, an additional certificate has to be manually installed on the 8301. To add this user certificate file use a '.pem' filetype extension and have the file named 'sipclient'. This is done by manually adding a file named 'sipclient.pem', which contains a device certificate and private key, to the 'certs' folder (under the 'Advanced Settings' tab File Manager). In the future, '.crt', '.cer', and '.der' certificate extensions will also be supported and you will not be restricted to naming the file 'sipclient.pem'.

Wiring Connections

The wiring diagram below illustrates one of the most common use cases, where the Line Output of the 8373 is connected directly to the dry audio input on an amplifier with an input impedance between 600 Ohm and 10 kOhm. The amplifier output is then connected back to the 8373 Amp In terminals and the speaker runs get wired to Channel 1, 2 or 3.

The 8373 output level can be adjusted to match the amplifier's input specification. Check the Basic Settings -> Features section for more details. The optional dry contact closure can be used to activate the amplifier (if required).

	Important: Please note the 8373 can switch <u>up to 280W</u> . Going over this might damage the internal components.
---	---

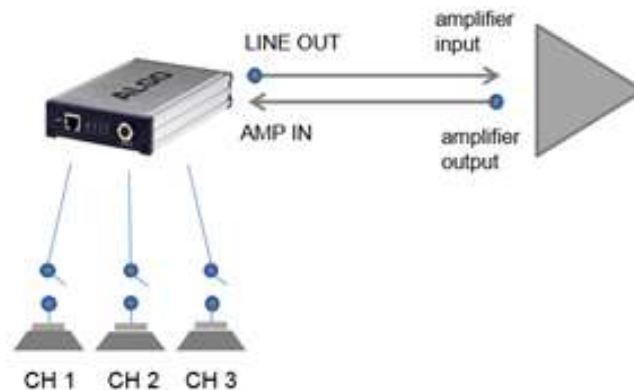

8373 Zone Paging Adapter: Front View

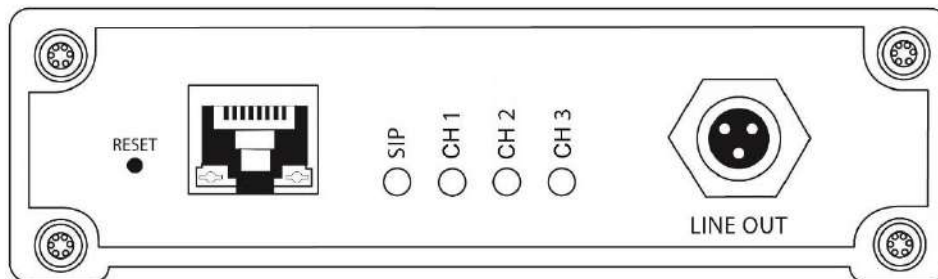

8373 Zone Paging Adapter: Back View

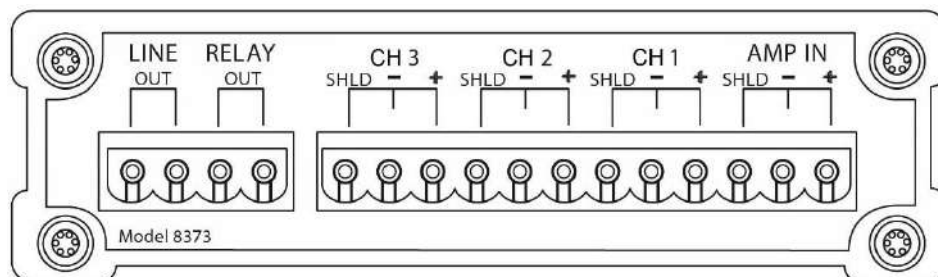

Network Connection (Front)

The 8373 provides a RJ45 jack for network connection. A cable run from the switch can be terminated to a modular jack with connection by patch cord, or terminated with a RJ45 plug.

PoE (Power over Ethernet) must be 48V 350 mA IEEE 802.3af compliant whether provided by the network switch or injector.

There are two lights on the Ethernet jack:

Green light: On when Ethernet is working, flickers off to indicate activity on the port.

Amber light: Off when successful 100Mbps link is established. Typically on only briefly at power up.

Under normal conditions, the Amber light will turn on immediately after the Ethernet cable is first connected. This indicates that PoE power has been successfully applied. Once the device connects to the network, it will switch to the Green light instead, which will typically flicker indicating traffic on the network.

Line Out XLR-Mini (Front)

Balanced and isolated audio output to external amplifier. Locking mini-XLR female to standard XLR male cable available. Output level defined using web interface.

Terminal Block Line Out (Back)

Wire pair output parallel to XLR-MINI LINE OUT that may be used for connecting to an external amplifier.

Terminal Block Relay Out (Back)

By default these terminals provide a contact closure when the 8373 Zone Paging Adapter is active. Please note this is a normally open relay only.

Channel 1/2/3 (Back)

The relays will switch audio from the amplifier to the appropriate output channels. The connections for the output of the external amplifier and distribution to up to three speaker runs (or channels) are identified as + (plus), - (minus), and SHLD (shield). The + and - only serve to maintain polarity if important for speaker phasing but will not normally be critical. The SHLD input and output is not connected to anything internally inside the 8373. The SHLD connections are all tied together and serve only as a convenience if using speaker wire with a shield. If the shield wire is connected to Earth Ground at the amplifier then Earth Ground will be distributed to each speaker run.

AMP IN (Back)

Connect the output of the amplifier.

Terminal Block Cover

When connected to 70V or 100V paging amplifiers, the included connector guard should be snapped onto the output terminal blocks (CH 1, 2, 3, and AMP IN) after wall mounting and wiring connections are made. The cover is designed to prevent accidental contact with the high voltage amplifier output.

Blue LED Indicators

SIP

Steady light will appear when the SIP extension is registered. The LED light will blink when the device is engaged in a SIP call.

Channel 1/2/3

Steady light when the channel is activated.

Note: All 4 blue LEDs will be on during power up and boot process.

Reset

A recessed reset button (RST) next to the Ethernet Jack can only be used to reset the 8373 Zone Paging Adapter at time of power up. To return all settings to a factory default, reboot or power cycle the 8373. Wait until the SIP LED flashes and then press and hold the reset button until the SIP LED begins a double flash pattern. Release the reset button and allow the unit to complete its boot process.

Do not press the reset button until the SIP LED begins flashing.

A reset will set all configuration options to factory default including the password.

Once booting has completed, pressing the reset button will cause the device to speak its IP address over the line out port.

Web Interface Status and Login

Web Interface login

Welcome to the Algo 8373 Zone Paging Adapter Control Panel

Setting up your Zone Paging Adapter:

Step 1: Configure your Zone Paging Adapter

Log in with the default password and use the Basic Settings pages to set up the basic information.

Step 2: Check network settings (Optional)

Use the Network page under the Advanced Settings tab to change network settings. The default setting for the device is to obtain its IP address from a DHCP server. Contact your Network System administrator if you plan to assign a static IP address, Mask, and Gateway to the device.

Step 3: Secure your Zone Paging Adapter (Optional)

Use the Admin page under the Advanced Settings tab to change the administrator password.
⚠ Changing the password is extremely important if the device is directly connected to a public network.

Step 4: Register your Zone Paging Adapter (Optional)

Please register your product using the link below:
<http://www.algosolutions.com/register>

Registration ensures your access to the latest upgrades to this product and important service notices.



Login

Password (default: **algo**)

Status

Device Name	zonepaging	
SIP Registration	Page	No Account
Call Status	Idle	
Proxy Status	Single proxy mode	
Security	TLS	Disabled
	SRTP	Disabled
Provisioning Status	None Found	
MAC	00:22:ee:0d:03:bf	
IP	10.30.28.77	
Netmask	255.0.0.0	
Gateway	10.0.1.1	
Date / Time	Thu Apr 9 16:38:46 UTC 2020	
Multicast Mode	Disabled	
Volume	Page Volume: 10 (0dB)	

The web interface requires a password which is 'algo' by default. This password can be changed using the **Admin** tab after logging in the first time.

	<i>Web Interface is accessed by entering the 8373's IP Address into a web browser.</i>
	<i>Important: It is highly recommended to change the default password if the device is directly connected to a public network.</i>

Status

The device's Status page will be available before and after log on. The section can be used to check 8373's SIP Registration, Call Status, Multicast Mode/Status, Relay Status, Proxy Status, and general MAC, IP, Netmask, Date/Time, and Timezone information.



*The Status page can be hidden when logged out for security purposes under the **Advanced Settings -> Admin** tab.*

Web Interface Basic Settings

Basic Settings Tab – SIP

SIP Server information and Credentials should be obtained from your telephone system administrator or hosted account provider. After saving the settings, see the Status tab to confirm the registration was successful.

The screenshot shows the 'SIP Settings' section of the web interface. It includes a help message: 'This section allows the SIP server information & account credentials to be entered. This information should be obtained from your telephone system administrator or hosted account provider. After saving these settings, see the [Status](#) tab to confirm successful registration.' Below this are four input fields: 'SIP Domain (Proxy Server)', 'Page Extension', 'Authentication ID', and 'Authentication Password'. A 'Save' button is at the bottom right.



Important: Any time changes are made to settings in the Web Interface the 'Save' key must be clicked to save the changes.

SIP Domain (Proxy Server)

The IP address (e.g. 192.168.1.111) or domain name (e.g. myserver.com) of the SIP Server.

Page Extension

This is the SIP extension for the 8373 Zone Paging Adapter. The Page Extension uses "DTMF Selectable Zone" mode. After the Page call is answered, use DTMF to enter a zone number in order to activate the desired relay(s). As an alternative, a unique extension can be assigned per zone in **Additional Features > More Page Extensions**.

Authentication ID

May also be called Username for some SIP servers and in some cases may be the same as the SIP extension.

Authentication Password

SIP password provided by the system administrator for the SIP account.

Basic Settings Tab – Features

Status | **Basic Settings** | Additional Features | Advanced Settings | System | Logout

SIP | **Features** | Channels | Multicast

Features

Test Tone Settings

Test Tone Play Loop Stop
ⓘ The test tone will play on all three channels, but will not stream over multicast

Test Speaker Volume Apply

Inbound Page Settings

Page Speaker Volume Apply

Page Mode One-way Delayed
ⓘ "Delayed" mode stores the page audio temporarily, and then broadcasts it after the call is hung-up. This can help avoid feedback.

Page Timeout

Page Tone
ⓘ Use only Default, or custom uploaded file. The other pre-installed tone files all contain silence at the end in order to generate ring "cadence" of 6 seconds. This silence will block the voice path for several seconds at the start of a page.

G.722 Support Enabled Disabled
ⓘ Applies to codec used during SIP negotiation only. Multicast codec is configured separately.

DTMF Detection Type Auto RTP Telephony Event (RFC 4733) RTP In-band SIP INFO

Audio

Automatic Gain Control (AGC) Enabled Disabled
ⓘ Automatically maximize level of voice received from calling phone in order to make page volume more consistent.

Output Level

Output

Output Relay Enabled Disabled

✔ Save

Test Tone

Select audio file to play over the associated speaker. The file may be played immediately to an associated speaker from the web interface for test purposes using the Play, Loop, and Stop buttons. The test tone will play on all three channels, but will not stream over multicast.

Test Speaker Volume

Set the associated speaker volume. This setting is an amplifier gain control and the output level will also depend on the levels recorded into the source audio file played from memory.

Page Speaker Volume

Speaker page volume control for SIP or multicast paging. This setting is an amplifier gain control and output level will depend on streaming level. This setting will apply to all multicast, regardless of content.

Page Mode

A call to the SIP page extension can be one-way or delayed. In delay mode, the adapter will store the page into memory and then play after disconnect.

In delay mode, press “*” to cancel a page while the recording state is in process to prevent it from being sent after hanging up.

Page Timeout

A time limit may be set for an active page.

Page Tone

Select pre-announce tone for paging. Use only Default, or custom uploaded file. The other pre-installed tone files all contain silence at the end in order to generate ring "cadence" of 6 seconds. This silence will block the voice path for several seconds at the start of a page. The "Default" tone will play the page-notif.wav file.

Note: The "Default Page Tone", in Advanced Multicast, will play the tone set here.

G.722 Support

Enable or disable the G.722 codec.

Automatic Gain Control (AGC)

Normalizes the audio level. This ensures audio level heard at the speaker is always at a consistent level, independent of the phone that is used to answer the call.

Output Level

The following output levels are available, allowing the 8373 to interface with a wide variety of devices:

+4dBu 10k (1.23 Vrms)
0dBu 10k (0.775 Vrms)
0dBV 10k (1.0 Vrms)
-10dBV 10k (0.316 Vrms)
0dBm 600 ohm (0.755 Vrms)
-10dBm 600 ohm (0.245 Vrms)
-20dBm 600 ohm (0.077 Vrms)

Basic Settings Tab – Channels

Select multicast zone(s) to play the audio on for each channel. A channel may be associated with any number of zones.

The screenshot shows the 'Basic Settings' tab with sub-tabs for SIP, Features, Channels, and Multicast. The 'Channels' sub-tab is active, displaying 'Audio Output Relay Settings'. Under 'General', there are radio buttons for 'Basic Zones Only' (selected) and 'Basic and Expanded Zones', with a note: 'The 8373 Page Extension always supports DTMF input mode to select zones for activating the Relay Channels, even when in stand-alone mode with multicast disabled.' Below are three channel settings sections: 'Channel 1 Settings', 'Channel 2 Settings', and 'Channel 3 Settings'. Each section has a 'Speaker Playback Zones' field with radio buttons for 'Priority Call', 'All Call', 'Music', and zones 1-6. In Channel 1, 'All Call' and 'Zone 1' are selected. In Channel 2, 'All Call' and 'Zone 2' are selected. In Channel 3, 'All Call' and 'Zone 3' are selected. A 'Save' button is at the bottom right.

Note: If Polycom Mode is enabled in the Basic Settings > Multicast tab, Polycom groups can be selected for each channel.

Number of Zones

Select “basic” zones if configuring nine or fewer multicast zones or “expanded” to configure up to 50 zones. The expanded zones have the same behaviour as the basic slave zones, but are hidden by default to simplify the interface.

The 8373 Page Extension always supports DTMF input mode to select zone for activating the Relay Channels, even when in stand-alone with multicast disabled.

Speaker Playback Zones

Allows each Channels to play audio for selected zones only.

Basic Settings Tab - Multicast (Master Settings)

Multicast IP Addresses

Each 8373 Zone Paging Adapter has its own IP address, and shares a common multicast IP and port number (multicast zone) for multicast packets. The master transmits to a configurable multicast zone, and the slave units listen to all the multicast zones assigned to them.

The network switches and router see the packet and deliver it to all the members of the group. The multicast IP and port number must be the same on all the master and slave

units of one group. The user may define multiple zones by picking different multicast IP addresses and/or port numbers.

1. Multicast IP addresses range: 224.0.0.0/4 (from 224.0.0.0 to 239.255.255.255)
2. Port numbers range: 1 to 65535
3. By default, the 8373 Zone Paging Adapter is set to use the multicast IP address 224.0.2.60 and the port numbers 50000-50008

Make sure that the multicast IP address and port number do not conflict with other services and devices on the same network.

Multicast Page Zones

The 8373 Zone Paging Adapter supports nine “basic” multicast zones. These zones are defined by the multicast IP addresses.

Somewhat arbitrarily, these zones are defined below but may be used in other ways. The important consideration is that there is a priority hierarchy – streaming activity on a zone higher on the list, will be treated as a higher priority than a zone lower on the list – with music being the lowest priority.

1. Priority
2. All Call
3. Zone 1
4. Zone 2
5. Zone 3
6. Zone 4
7. Zone 5
8. Zone 6
9. 9.Music

“Expanded” zones can also be enabled, in the Basic Settings > Multicast tab, allowing up to 50 zones in total. These have the same behaviors as the basic zones, but are hidden by default to simplify the interface.

Basic Settings Tab - Multicast (Master Settings)

 *Note: See (Advanced Settings > Advanced Multicast) section for more information on populated IP values.*

Multicast Mode (Master/Sender Selected)

If master is enabled the 8373 Zone Paging Adapter will broadcast an IP stream when activated in addition to playing the audio. (Note that the 8373 Zone Paging Adapter cannot be both a multicast master and slave simultaneously).

Number of Zones (Regular Multicast Type Selected)

Select “basic” zones if configuring nine or fewer multicast zones or “expanded” to configure up to 50 zones. The expanded zones have the same behaviour as the basic Slave zones, but are hidden by default to simplify the interface.

Multicast Type

The 8373 Zone Paging Adapter may broadcast multicast paging, compatible with Polycom ‘**on premise group paging**’ protocol and most multicast-enabled phones that use RTP audio packets.

Select ‘Regular’ if solely multicasting to Algo SIP endpoints and/or multicast-enabled phones.

To multicast page announcements solely to Polycom phones, select “Polycom Group Page” or “Push-to-Talk”. Then, configure the 8373 with the “Polycom Zone” (IP Address and Port).

Note: Always ensure that the multicast settings on all Slaves match those of the Master.

Select “Regular RTP + Polycom Group Page/Push-to-Talk” to multicast page audio to both Polycom phones, Algo SIP endpoints, and multicast-enabled phones.

Basic Settings Tab - Multicast (Slave Settings)

The screenshot shows the 'Multicast Settings' page. At the top, there are navigation tabs: Status, Basic Settings (selected), Additional Features, Advanced Settings, System, and Logout. Below these are sub-tabs: SIP, Features, Channels, and Multicast (selected). The main content area is titled 'Multicast Settings' and contains two sections:

- Multicast Mode:**
 - Multicast Mode: None, Master/Sender, Slave/Receiver. A note indicates: "Multicast Zone Definitions can be found in 'Advanced Settings > Advanced Multicast'".
 - Number of Zones: Basic Zones Only, Basic and Expanded Zones. A note indicates: "The 8373 Page Extension always supports DTMF input mode to select zones for activating the Relay Channels, even when in stand-alone mode with multicast disabled."
- Polycorn Group Paging/Push-to-Talk:**
 - Multicast Type: Regular (RTP), Polycorn Group Page, Polycorn Push-to-Talk. A note indicates: "Regular mode uses RTP audio packets compatible with all Algo SIP endpoints, and most multicast-enabled phones."

A 'Save' button with a green checkmark is located at the bottom right of the settings area.

Multicast Mode (Slave Selected)

If Slave mode is enabled the 8373 will activate when receiving a multicast message. It will mimic the audio stream, but use local volume settings ('Page Speaker Volume' in Basic Settings > Features).

Number of Zones (Regular Multicast Type Selected)

Select "basic" zones if configuring nine or fewer multicast zones or "expanded" to configure up to 50 zones. The expanded zones have the same behaviour as the basic Slave zones.

Multicast Type - Regular

Select "Regular" if solely multicasting to Algo SIP endpoint(s) and/or multicast-enabled phone(s) that use RTP audio packets.

Multicast Type – Polycom Group Paging/Push-to-Talk

The 8373 may receive multicast paging compatible with Polycom "on premise group paging" protocol.

To configure the 8373 as a slave to play Polycom page announcements, select "Group Page" or "Push-to-Talk". Then enter the Polycom Zone (IP Address and Port) that matches the configuration of the Polycom phones and Channels. The "Default Channel" is the target group in a Polycom paging environment.

The Polycom phone used as page audio source for the 8373, must be configured to use either the G.711 or G.722 audio codec. **The Polycom phone(s) must also be configured with the "Compatibility" setting ("ptt.compatibilityMode") disabled** in order for this codec setting to be applied.

If using a Polycom phone as the Multicast master, a tone may be set for any of the 25 Polycom Groups configured on the Algo device. If an Algo device is used as a Multicast master, a tone does not have to be set as the Algo master will provide its own tone. Polycom Group Tones can be set in Advanced Settings > Advanced Multicast tab.

Web Interface Additional Features

Additional Features Tab – More Page Extensions

Status Basic Settings **Additional Features** Advanced Settings System Logout

More Page Extensions

This section allows dedicated extensions to be registered for each paging zone. This provides an alternative to the "DTMF Selectable Zone" option, thus allowing any zone to be called directly without the need to enter DTMF. Depending on the features available on your SIP phone system, this can provide benefits in allowing speed-dial keys to be programmed on user phones for paging a particular zone more easily, or dialing restrictions could potentially be used to allow only selected phones to access certain zones. This feature requires several SIP extensions to be registered with the SIP phone system.

i The 8373 will auto-answer any inbound calls received on these numbers and provide a voice paging path and multicast if configured. Note that only a single call can be active at a time.

i Note: Some SIP phone systems may not support this feature if they limit the number of extensions that can be registered on a single device.

i Multicast Zone Definitions can be found in "Advanced Settings > [Advanced Multicast](#)".

Basic Extensions

Zone 1 Page Extension	<input checked="" type="radio"/> Enabled <input type="radio"/> Disabled
Extension	<input type="text"/>
Authentication ID	<input type="text"/>
Authentication Password	<input type="password"/>
Display Name (Optional)	<input type="text"/>
Zone 2 Page Extension	<input type="radio"/> Enabled <input checked="" type="radio"/> Disabled
Zone 3 Page Extension	<input type="radio"/> Enabled <input checked="" type="radio"/> Disabled
Zone 4 Page Extension	<input type="radio"/> Enabled <input checked="" type="radio"/> Disabled
Zone 5 Page Extension	<input type="radio"/> Enabled <input checked="" type="radio"/> Disabled
Zone 6 Page Extension	<input type="radio"/> Enabled <input checked="" type="radio"/> Disabled
Zone 7 Page Extension	<input type="radio"/> Enabled <input checked="" type="radio"/> Disabled
Zone 8 Page Extension	<input type="radio"/> Enabled <input checked="" type="radio"/> Disabled
Zone 9 Page Extension	<input type="radio"/> Enabled <input checked="" type="radio"/> Disabled

 Save

Additional SIP extensions can be registered for each multicast zone that will be used. This allows the advantage of dialing directly to a zone without needing to enter DTMF (e.g. speed-dial keys can be used), but may require additional SIP licenses depending.

To configure additional page extensions (up to 50) click "Enable" beside the target extension and enter the Extension, Authentication ID, and Authentication password.

The 8373 will auto-answer any inbound calls received on these numbers and provide a voice paging path and multicast if configured. Note that only a single call can be active at a time.

 *Note: Some SIP phone systems may not support this feature if they limit the number of extensions that can be registered on a single device.*

Web Interface Advanced Settings

Advanced Settings Tab - Network

The screenshot displays the 'Advanced Settings' tab for the 'Network' section. The interface includes a navigation bar with tabs for 'Status', 'Basic Settings', 'Additional Features', 'Advanced Settings' (selected), 'System', and 'Logout'. Below this, there are sub-tabs for 'Network', 'Admin', 'Time', 'Provisioning', 'File Manager', 'Advanced Audio', 'Advanced SIP', and 'Advanced Multicast'. The main content area is titled 'Network Settings' and is organized into several sections:

- Network Interface:** Features a 'Protocol' section with radio buttons for 'Static IP' (selected) and 'DHCP'. Below are input fields for 'IP Address', 'Netmask', 'Gateway', 'DNS Server 1', and 'DNS Server 2'.
- 802.1Q Virtual LAN:** Includes a 'VLAN Mode' section with radio buttons for 'None', 'Manual', and 'Auto' (selected).
- 802.1X Port-based Network Access Control:** Features an '802.1X Authentication' section with radio buttons for 'Enabled' (selected) and 'Disabled'. Below are input fields for 'ID' and 'Password'.
- Differentiated Services:** Includes three input fields for 'SIP (6-bit DSCP value)', 'RTP (6-bit DSCP value)', and 'RTCP (6-bit DSCP value)', each with a help icon and the text 'Valid values range from 0 to 63'.
- DNS:** Features a 'DNS Caching Mode' section with radio buttons for 'Disabled' (selected), 'SIP', and 'All'. A note below states: 'In "SIP" mode, only the results of DNS queries for SIP requests will be cached. In "All" mode, the results of all DNS queries will be cached.'

A 'Save' button with a green checkmark is located at the bottom right of the form.

Protocol

DHCP is an IP standard designed to make administration of IP addresses simpler. When selected, DHCP will automatically configure IP addresses for each 8373 Zone Paging Adapter on the network. Alternatively the 8373 Zone Paging Adapter can be set to a static IP address.

VLAN Mode

Enables or Disables VLAN Tagging. VLAN Tagging is the networking standard that supports Virtual LANs (VLANs) on an Ethernet network. The standard defines a system of VLAN tagging for Ethernet frames and the accompanying procedures to be used by bridges and switches in handling such frames. The standard also provides provisions for a quality of service prioritization scheme commonly known as IEEE 802.1p and defines the Generic Attribute Registration Protocol.

VLAN ID

Specifies the VLAN to which the Ethernet frame belongs. A 12-bit field specifying the VLAN to which the Ethernet frame belongs. The hexadecimal values of 0x000 and 0xFF are reserved. All other values may be used as VLAN identifiers, allowing up to 4094 VLANs.

The reserved value 0x000 indicates that the frame does not belong to any VLAN; in this case, the 802.1Q tag specifies only a priority and is referred to as a priority tag. On bridges, VLAN 1 (the default VLAN ID) is often reserved for a management VLAN; this is vendor specific.

VLAN Priority

Sets the frame priority level. Otherwise known as Priority Code Point (PCP), VLAN Priority is a 3-bit field which refers to the IEEE 802.1p priority. It indicates the frame priority level. Values are from 0 (lowest) to 7 (highest).

802.1x Authentication

Credentials to access LAN or WLAN that have 802.1X network access control (NAC) enabled. This information will be available from the IT Administrator.

Differentiated Services (6-bit DSCP value)

Provides quality of service if the DSCP protocol is supported on your network. Can be specified independently for SIP control packets versus RTP and RTCP audio packets.

DNS Caching Mode

In "SIP" mode, only the results of DNS queries for SIP requests will be cached. In "All" mode, the results of all DNS queries will be cached.

Advanced Settings Tab – Admin

The screenshot shows the 'Advanced Settings' tab for the 'Admin' section. The navigation bar includes 'Status', 'Basic Settings', 'Additional Features', 'Advanced Settings', 'System', and 'Logout'. The sub-navigation bar includes 'Network', 'Admin', 'Time', 'Provisioning', 'File Manager', 'Advanced Audio', 'Advanced SIP', and 'Advanced Multicast'.

Admin Settings

Admin Password

Password:
 Confirmation:

General

Device Name (Hostname):
 Introduction Section on Status Page: On Off
 Show Status Section on Status Page when Logged Out: On Off
 Web Interface Session Timeout:
Automatically log out web interface after period of inactivity.
 Play Tone at Startup: Enabled Disabled
A tone can be played at startup to confirm that the device has booted. This can be useful when testing or configuring a device, but might not be desirable if the device is connected to an external amplifier and paging system.

Log Settings

Log Level: Error (Lowest) Notice ("Event") Info ("SIP") Debug (Highest)
 Log Method: Local Network Both

Management

Web Interface Protocol: Both HTTP and HTTPS HTTPS Only
 Force Strong Password: Enabled Disabled
 Allow Secure SIP Passwords: Enabled Disabled
After enabling this option, it is recommended to re-enter SIP passwords and their corresponding realm to store the passwords securely.
 SNMP Support: Enabled Disabled
Download MIB file [here](#).

System Integrity

System Integrity Checking: Enabled Disabled
This feature verifies installed system packages to ensure they have not been tampered with. Enabling this feature may cause reboots and upgrades to take 30 seconds longer. Verification results can be found on the Status page.

Save

Password

Password to log into the 8373 Zone Paging Adapter web interface. You should change the default password **algo** in order to secure the device on the network. If you have forgotten your password, you will need to perform a reset using the Reset Button in order to restore the password (as well as all other settings) back to the original factory default conditions.

For additional password security see 'Force Strong Password' below.

Confirmation

Re-enter network admin password.

Device Name (Hostname)

Name to identify the device in the Algo Network Device Locator Tool.

Introduction Section on Status Page

Allow the introduction text to be hidden from the login screen.

Show Status Section on Status Page when Logged Out

Use this option if you wish to block access to the status page when logged out. The settings and configurations, on the status page, will be hidden entirely unless you're logged in- this feature is useful when you want only trusted users to view possible sensitive device information.

Web Interface Session Timeout

Set the maximum period of inactivity after which the web interface will log out automatically.

Play Tone at Startup

A tone can be played at startup to confirm that the device has booted. This can be useful when testing or configuring a device, but might not be desirable if the device is connected to an external amplifier and paging system.

Log Level

Use on the advice of Algo technical support only.

Log Method

Allows the 8373 Zone Paging Adapter to write to external Syslog server if the option for external (or both) is selected.

Log Server

If "Network" or "Both" is selected this is the address of the Syslog server on the network.

Web Interface Protocol

HTTPS is always enabled on the device. Use "HTTPS Only" mode to disable HTTP, then requests will be automatically redirected to HTTPS. Also note that since the device can have any address on the local network, no security certificate exists, and thus most browsers will provide a warning when using HTTPS.

Force Strong Password

When enabled, ensures that a secure password is provided for the device's web interface for additional protection. The password requirements are:

- Must contain at least 10 characters
- Must contain at least 1 uppercase character
- Must contain at least 1 digit (0 – 9)
- Must contain at least 1 special character

Allow Secure SIP Password

Allows SIP passwords to be stored in the configuration file in an encrypted format, to prevent viewing and recovery. Once enabled, the SIP "Realm" field should be entered and all the configured Authentication Password(s) must be re-entered in the Basic Settings > SIP tab, and any other locations where SIP extensions have been configured, to save the encrypted password(s).

If the Realm is changed at a later time, all the passwords will also need to be re-entered again to save the passwords with the new encryption.

To obtain your SIP Realm information, contact your SIP Server administrator (or check the SIP log file for a registration attempt). The Realms may be the same or different for all the extensions used.

SNMP Support

Additional SNMP support is anticipated for future, but the 8373 Zone Paging Adapter will respond to a simple status query for automated supervision. Contact Algo technical support for more information.

System Integrity Checking

This feature verifies installed system packages to ensure they have not been tampered with by running 'Perform Check'. Enabling this feature may cause reboots and upgrades to take 30 seconds longer. Verification results can be found on the Status page.

Advanced Settings Tab – Time

The screenshot shows the 'Advanced Settings' tab for the 'Time' section. The 'General' sub-section contains the following fields:

- Timezone: UTC
- NTP Time Server 1: 0.debian.pool.ntp.org
- NTP Time Server 2: 1.debian.pool.ntp.org
- NTP Time Server 3: 2.debian.pool.ntp.org
- NTP Time Server 4: 3.debian.pool.ntp.org
- NTP Time Server Source: Use DHCP Option 42 Ignore DHCP Option 42
- Device Date/Time: Thu Apr 9 16:45:29 2020 Sync with browser

A 'Save' button is located at the bottom right of the form.

Network time is used for logging events into memory for troubleshooting.

Time Zone

Select time zone.

NTP Time Servers 1/2/3/4

The adapter will attempt to use Timer Server 1 and work down the list if one or more of the time servers become unresponsive.

NTP Time Server Source

When "Use DHCP Option 42" is chosen, if an NTP Server address is provided via the DHCP Option 42, that NTP Server will be used instead of the 4 mentioned above. Alternatively, "Ignore DHCP Option 42" can be chosen to only use servers mentioned above.

Device Date/Time

This field shows the current time and date as set on the device. If testing the device on a lab network that may not have access to an external NTP server, the "Sync with browser" button can be used to temporarily set the time on the device.



Note: This time value will be lost at power down, or overwritten if NTP is currently active. Time and date used only for logging purposes and are not typically required.

Advanced Settings Tab – Provisioning

 *Note: It is recommended that Provisioning Mode be set to Disabled if this feature is not in use. This will prevent unauthorized re-configuration of the device if DHCP is used.*

Provisioning allows installers to pre-configure 8373 Zone Paging Adapter units prior to installation on a network. It is typically used for large deployments to save time and ensure consistent setups.

The device can be provisioned via the Auto mode (where all three DHCP options (Option 66/160/150) will be automatically checked for an active provisioning server), just one of the three specified DHCP options, or a Static Server. In addition, there are four different ways to download provisioning files from a “Provisioning Server”: TFTP (Trivial File Transfer Protocol), FTP, HTTP, or HTTPS.

For example, 8373 configuration files can be automatically downloaded from a TFTP server using DHCP Option 66. This option code (when set) supplies a TFTP boot server address to the DHCP client to boot from.

 *Important: DHCP must be enabled if using DHCP Option 66/160/150, in order for Provisioning to work.*

One of two files can be uploaded on the Provisioning Server (for access via TFTP, FTP, HTTP, or HTTPS):

Generic (for all 8373 Paging Adaptors)

algot8373.conf

Specific (for a specific MAC address)

algot[MAC].conf

Both protocol and path is supported for Option 66, allowing for <http://myserver.com/config-path> to be used.

MD5 Checksum

In addition to the .conf file, an .md5 checksum file must also be uploaded to the Provisioning server. This checksum file is used to verify that the .conf file is transferred correctly without error.

A tool such as can be found at the website address below may be used to generate this file: <http://www.fourmilab.ch/md5>

The application doesn't need an installation. To use the tool, simply unzip and run the application (md5) from a command prompt. The proper .md5 file will be generated in the same directory.

If using the above tool, be sure to use the "-l" parameter to generate lower case letters.

Generating a generic configuration file

1. Connect 8373 to the network
2. Access the 8373 Web Interface Control Panel
3. Configure the 8373 with desired options
4. Click on the System tab and then Maintenance.
5. Click "Download" to download the current configuration file
6. Save the file settings.txt
7. Rename file settings.txt to algop8373.conf
8. The file algop8373.conf can now be uploaded onto the Provisioning server

If using a generic configuration file, extensions and credentials have to be entered manually once the 8373 has automatically downloaded the configuration file.

Generating a specific configuration file

1. Follow steps 1 to 6 as listed in the section "Generating a generic configuration file".
2. Rename file settings.txt to algom[MAC address].conf (e.g. algom0022EE020009.conf)
3. File algom[MAC address].conf can now be uploaded on the Provisioning server.

The specific configuration file will only be downloaded by the 8373 with the MAC address specified in the configuration file name. Since all the necessary settings can be included in this file, the 8373 will be ready to work immediately after the configuration file is downloaded. The MAC address of each 8373 can be found on the back label of the unit.

For more Algo SIP endpoint provisioning information, see:

www.algosolutions.com/provision

Advanced Settings Tab – File Manager

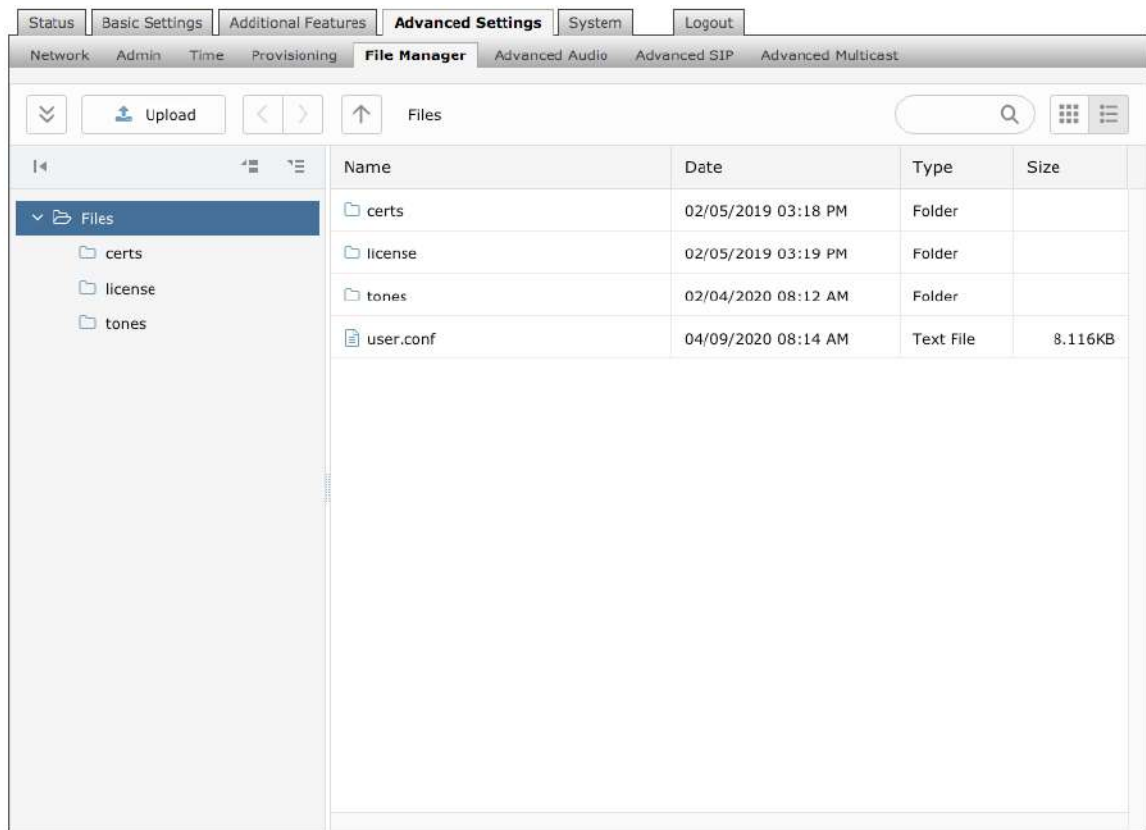

Uploading Custom Audio Files

Custom audio files may be uploaded into memory (1 GB) to play for notification applications. Place your audio files into the **tones** directory.

An existing file may also be modified by downloading the original via the links in the web interface, making the desired changes, and then uploading the new version with a different name. Audio files must be in the following format:

- WAV format
- 8kHz or 16kHz sampling rate
- 16-bit PCM, or u-law
- Mono
- Smaller than 200MB

File names must be limited to 32 characters, with no spaces.

For further instructions reference the [Custom Tone Conversion and Upload Guide](#).

Tone Files Included in Memory

The 8373 Zone Paging Adapter includes several pre-loaded audio files that can be selected to play for various events. The web interface allows selection of the tone file and also the ability to play it immediately over the speaker for testing. Files may also be deleted or renamed.

Advanced Settings Tab – Advanced Audio

The screenshot shows the 'Advanced Audio Functions' configuration page. At the top, there are navigation tabs: Status, Basic Settings, Additional Features, **Advanced Settings**, System, and Logout. Below these are sub-tabs: Network, Admin, Time, Provisioning, File Manager, **Advanced Audio**, Advanced SIP, and Advanced Multicast. The main content area is titled 'Advanced Audio Functions' and is divided into two sections: 'Functions' and 'Audio Filters'.
Functions Section:
 - **Dynamic Range Compression (DRC):** Enabled (radio button selected). Description: Compress the dynamic range of page audio to increase loudness.
 - **Dynamic Range Compression Gain:** 6 (dropdown menu). Description: Specify the amount of compression gain. More gain increases distortion.
 - **Jitter Buffer Range (milliseconds, 10 ~ 500):** 100 (text input). Description: Adds more buffering if necessary to correct for inconsistent delays on the network. Use of the lowest value generally is recommended.
 - **Always Send RTP Media:** Enabled (radio button selected).
Audio Filters Section:
 - **Speaker Filter:** None (dropdown menu). Description: Bandwidth also limited by audio codecs.
 - **Speaker Noise Filter:** Enabled (radio button selected). Description: Aggressive 8th order Elliptical Filter (fc = 145Hz).
 A 'Save' button with a green checkmark is located at the bottom right of the configuration area.

Dynamic Range Compression (DRC)

If enabled, compresses the dynamic range of page audio to increase loudness.

Dynamic Range Compression Gain

Higher compression gain increases distortion.

Jitter Buffer Range

The jitter buffer removes the jitter in arriving network packets by temporarily storing them. This process corrects the inconsistent delays on the network. It is recommended to use the lowest value.

Always Send RTP Media

If enabled, audio packets will be sent at all times, even during one way paging mode. This option is needed in cases when the server expects to see audio packets at all times.

Speaker Filter

Applies a high-pass filter to the speaker output. Used to reduce audio artifacts like humming or buzzing by filtering out unwanted frequencies.

Speaker Noise Filter

Enables heavy filtering below 145Hz to reduce mains induced noise (fans).

Advanced Settings Tab – Advanced SIP

SIP Transportation

Which transport layer protocol to use for SIP messages. Setting 'SIP Transportation' to 'TLS', ensures the encryption of SIP traffic.

SIPS Scheme

Only visible when 'SIP Transportation' set to 'TLS'. Enabling SIPS Scheme requires the SIP connection from endpoint to endpoint to be secure.

SDP SRTP Offer

Setting 'SDP SRTP Offer' to 'Optional', means the SIP call's RTP data will be left unencrypted if the other party does not support SRTP. Setting 'SDP SRTP Offer' to 'Standard', encrypts RTP voice data, meaning the normal audio RTP packets will now be secure (SRTP). This means SIP calls will be rejected if other party does not support SRTP. The 'Standard' option secures the audio data between parties, by making sure that it's not left out in the open for third parties to later reconstruct and listen to.

SIP Outbound Support (RFC 5626)

Enable this option to support best networking practices according to RFC 5626. This option should generally be enabled if the Algo device is being registered with a hosted server or if TLS is being used for SIP Transportation.

Outbound Proxy

IP address for outbound proxy. A proxy (server) stands between a private network and the internet.

Register Period (seconds)

Maximum requested period of time where the 8373 Zone Paging Adapter will re-register with the SIP server. Default setting is 3600 seconds (1 hour). Only change if instructed otherwise.

Media NAT

IP address for STUN server if present or IP address/credentials for a TURN server.

Server Redundancy	
Server Redundancy Feature (Multiple SIP Server Support)	<input checked="" type="radio"/> Enabled <input type="radio"/> Disabled
Backup Server #1	<input type="text"/>
Backup Server #2	<input type="text"/>
Polling Interval (seconds)	120 seconds (2 minutes) <input type="text"/>
	<small>Time to wait between sending monitoring packets to each server. Inactive servers are always polled and the active server may optionally be polled (see below).</small>
Poll Active Server	<input type="radio"/> Enabled <input checked="" type="radio"/> Disabled
	<small>Explicitly poll the current server to monitor its availability. Polling may also be handled automatically by other regular events, so this can be disabled to reduce network traffic.</small>
Automatic Failback	<input checked="" type="radio"/> Enabled <input type="radio"/> Disabled
	<small>Reconnect with a higher priority server once available, even if the backup connection is still working.</small>
Polling Method	<input checked="" type="radio"/> SIP NOTIFY <input type="radio"/> SIP OPTIONS
	<small>SIP message used to poll servers in order to monitor their availability.</small>

Interoperability	
Use Outgoing TLS port in SIP headers	<input checked="" type="radio"/> Enabled <input type="radio"/> Disabled
	<small>Use ephemeral port number from outgoing SIP TLS connection instead of listening port number in SIP Contact and Via headers. This is useful to connect the device to some local SIP servers, like Asterisk or FreeSWITCH.</small>
Do Not Reuse Authorization Headers	<input type="radio"/> Enabled <input checked="" type="radio"/> Disabled
	<small>When enabled, all SIP authorization information from the last successful request will not be reused in the next request.</small>
Allow Missing Subscription-State Headers	<input type="radio"/> Enabled <input checked="" type="radio"/> Disabled
	<small>When enabled, allow SIP NOTIFY messages that do not contain a "Subscription-State" header.</small>

Save

Server Redundancy Feature

Two secondary SIP servers may be configured. The 8373 Zone Paging Adapter will attempt to register with the primary server but switch to a secondary server when necessary. The configuration allows re-registration to the primary server upon availability or to stay with a server until unresponsive.

If Server Redundancy is selected the web page will expand as shown below.

Backup Server #1

If primary server is unreachable the 8373 Zone Paging Adapter will attempt to register with the backup servers. If enabled, the 8373 will always attempt to register with the highest priority server.

Backup Server #2

If backup server #1 is unreachable the 8373 Zone Paging Adapter will attempt to register with the 2nd backup server. If enabled, the 8373 will always attempt to register with the highest priority server.

Polling Intervals (seconds)

Time period between sending monitoring packets to each server. Non-active servers are always polled, and active server may optionally be polled (see below).

Poll Active Server

Explicitly poll current server to monitor availability. May also be handled automatically by other regular events, so can be disabled to reduce network traffic.

Automatic Failback

Reconnect with higher priority server once available, even if backup connection is still fine.

Polling Method

SIP message used to poll servers to monitor availability.

Use Outgoing TLS port in SIP headers

Use ephemeral port number from outgoing SIP TLS connection instead of listening port number in SIP Contact and Via headers. This is useful to connect the device to some local SIP servers, like Asterisk or FreeSWITCH.

Do Not Reuse Authorization Headers

When enabled, all SIP authorization information from the last successful request will not be reused in the next request.

Allow Missing Subscription-State Headers

When enabled, allow SIP NOTIFY messages that do not contain a "Subscription-State" header.

Advanced Settings Tab – Advanced Multicast

Status Basic Settings Additional Features Advanced Settings System Logout

Network Admin Time Provisioning File Manager Advanced Audio Advanced SIP Advanced Multicast

Advanced Multicast Settings

Current multicast mode: Master
Multicast mode can be set in "Basic Settings > Multicast"

Master Settings

Master Output Codec:

Master Output Packetization Time (milliseconds):

RTP Control Protocol (RTCP)

RTCP Port Selection: Disabled Next Higher Port Multiplexed on Same Port

Select the port on which packets will be sent or received.
If using the 'Next Higher Port' option, ensure that the default multicast zone definitions are modified such that zones are only assigned to even-numbered ports, leaving the next higher odd-numbered ports free for RTCP packets.

Basic Zone Definition

Zone	IP Address and Port	Page Tone
Priority Call (DTMF:9)	<input type="text" value="224.0.2.80:50000"/>	<input type="text" value="<Use Default Page Tone>"/>
All Call (DTMF:0/8)	<input type="text" value="224.0.2.80:50001"/>	<input type="text" value="<Use Default Page Tone>"/>
Zone 1 (DTMF:1)	<input type="text" value="224.0.2.80:50002"/>	<input type="text" value="<Use Default Page Tone>"/>
Zone 2 (DTMF:2)	<input type="text" value="224.0.2.80:50003"/>	<input type="text" value="<Use Default Page Tone>"/>
Zone 3 (DTMF:3)	<input type="text" value="224.0.2.80:50004"/>	<input type="text" value="<Use Default Page Tone>"/>
Zone 4 (DTMF:4)	<input type="text" value="224.0.2.80:50005"/>	<input type="text" value="<Use Default Page Tone>"/>
Zone 5 (DTMF:5)	<input type="text" value="224.0.2.80:50006"/>	<input type="text" value="<Use Default Page Tone>"/>
Zone 6 (DTMF:6)	<input type="text" value="224.0.2.80:50007"/>	<input type="text" value="<Use Default Page Tone>"/>
Music (DTMF:7)	<input type="text" value="224.0.2.80:50008"/>	<input type="text" value="<Use Default Page Tone>"/>

Expanded Zone Definition

Zone	IP Address and Port	Page Tone
Zone 10 (DTMF: *10)	<input type="text" value="224.0.2.110:50000"/>	<input type="text" value="<Use Default Page Tone>"/>
Zone 11 (DTMF: *11)	<input type="text" value="224.0.2.111:50000"/>	<input type="text" value="<Use Default Page Tone>"/>

Note: The settings on this tab are only visible when in master or slave multicast mode.

The default prepopulated multicast addresses above will work in most cases and should only be altered for rare cases.

Audio Sync (Slave Mode)

When using multicast with other third-party devices that have a delay in their audio path, the audio on the 8373 may be heard slightly earlier than on these other devices. By adding audio delay up to one second, the 8373 may be synchronized with other speakers or telephones that have greater latency. This feature applies to Multicast Slave mode only..

Master Output Codec (Master Mode)

Audio encoding format used by the master device when sending output to the slaves.

Master Output Packetization Time (Master Mode)

The size of the audio packets sent by the Master to the Slaves. The default of 20ms is recommended, unless a different value is specifically required for compatibility with other devices.

RTCP Port Selection

Select the port on which RTCP packets will be sent or received. If using the 'Next Higher Port' option, ensure that the default multicast zone definitions are modified such that zones are only assigned to even-numbered ports, leaving the next higher odd-numbered ports free for RTCP packets.

Zone Definition

The “Expanded” Slave or Master zones can be enabled/disabled in Basic Settings > Multicast. Default IP addresses and ports may be revised for any given zone in the table.



Important: Ensure that the Address and Port settings are the same for all master and slave devices.

Page Tone and Page Volume

Master Mode: By default, the same tone can be set for all slave zones in the Basic Settings > Features tab. Unique paging tones may be revised for any given slave zone in the table above.

Slave Mode: When an Algo device is the multicast master, a page tone will play on the slave device, so it is recommended to set the slave tone to “None”. If a page is received from a non-Algo device that doesn’t send a tone, a tone can be inserted on the slaves (above) each time they detect page audio starting, allowing them to play a tone.

By default, the same page volume can be set for all slave zones in the Basic Settings > Features tab. Unique page volumes may be revised on a per-zone basis in the table above. For instance, emergency pages can be louder on certain slave speakers.

Polycom Slave Tones

Available if Multicast Slave and “Polycom Group Page” or “Polycom Push-to-Talk” are selected in the Basic Settings > Multicast tab. A tone may be set for any of the 25 Polycom Groups. If using an Algo device as a Multicast master, it is recommended to set the slave tones to “None” to avoid conflicts, as the Algo devices already multicast a tone by default.

Web Interface System

System Tab – Maintenance

Status Basic Settings Additional Features Advanced Settings **System** Logout

Maintenance System Log Credits About

System Maintenance

Backup / Restore Configuration

Download Configuration File

Restore Configuration File

Restore Configuration to Defaults

Backup / Restore All User Files

Backup in zip format includes configuration file and all uploaded files.

Download Backup Zip File

Restore from Backup Zip File

Restore All Settings and Files to Defaults
ⓘ All preloaded and uploaded files, including tone files, will be deleted.

Reboot

Reboot the device

Upgrade to New Firmware

Method From Local Files From URL

Firmware Image

MD5 Checksum

Download Configuration File

Save the device settings to a text file for backup or to setup a provisioning configuration file.

Restore Configuration File

Restore settings from a backup file.

Restore Configuration to Defaults

Resets all 8373 Zone Paging Adapter device settings to factory default values.

Download Backup Zip File

Saves the device settings (configuration) and all the files in File Manager: certificates, licenses, and tones to a backup zip file.

Restore from Backup Zip File

Restores the device settings (configuration) and all the files in File Manager: certificates, licenses, and tones from a backup zip file.

Restore All Settings and Files to Defaults

Resets the device settings (configuration) and all the files in File Manager: certificates, licenses, and tones to factory default values.

Reboot the Device

Reboots the device.

Method

Specify whether the firmware files will be downloaded from the local computer or a remote URL.

Firmware Image

Point to the firmware image provided by Algo.

MD5 Checksum

Point to the checksum file provided by Algo

How to upgrade the 8373 Zone Paging Adapter Firmware

1. From the top menu, click on System, then Maintenance.
2. In the Upgrade section, click on Choose File and select the 8373 Zone Paging Adapter firmware file to upload. Note that both the FW firmware and MD5 checksum files must be loaded.
3. Click Upgrade
4. After the upgrade is complete, confirm that the firmware version has changed (refer to top right of Control Panel).

System Tab – System Log

System log files are automatically created and assist with troubleshooting in the event the 8373 Zone Paging Adapter does not behave as expected.

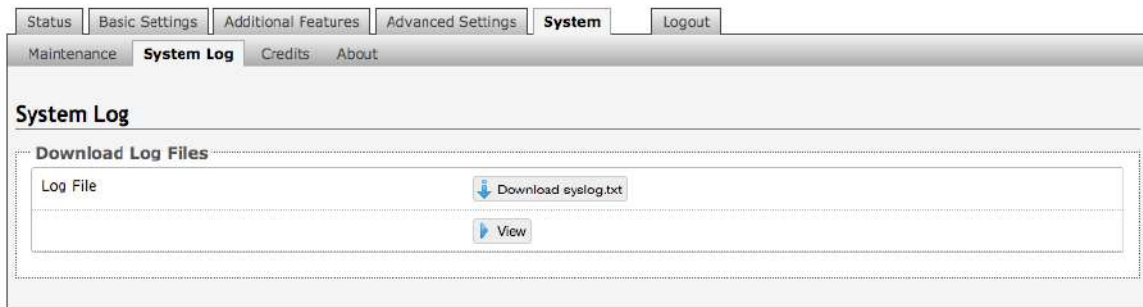

Specifications

Power Input:	PoE (IEEE 802.3af Class 0) 48V, 12.95W (Max 4W - Idle nominal 2W)
SIP:	SIP Extensions: <ul style="list-style-type: none">• 50 Page SIP Signalling/Transport Protocols: UDP, TCP, TLS, RTP, SRTP
Multicast & Third-Party Compatibility:	RTP Multicast (Send and Receive 50 Zones) Polycom Group Page
Configuration & Provisioning:	Configuration: Web interface or provisioning server Web Interface: HTTP, HTTPS Provisioning: TFTP, FTP, HTTP, HTTPS DHCP Options 66, 150, 160 Reboot via SIP 'check-sync' Supervision: Compatible with any third-party SNMP monitoring software or the Algo 8300 Controller.
Networking:	Networking: IPv4, DHCP, VLAN Link Layer: LLDP, CDP QoS: DSCP (SIP, RTP, RTCP) NAT: STUN, TURN, CRLF Keep Alive, SIP Outbound Address Resolution: DNS, SRV Record Redundancy: Secondary and tertiary SIP server Time: NTP Server (up to four)
Audio:	Audio Codecs: G.711 u-law, G.711 A-law, G.722 Wideband Audio Memory: 1 GByte audio storage
Input/Output:	Relay Output: Max 30 V 50 mA (normally open)
Environmental & Mechanical:	Environmental: 0 to + 40° C (32 to 104° F); 10-95% RH non-condensing. Dry indoor locations only. Dimensions (Product): 6.75" x 4.3" x 1.18" (17.2 cm x 10.9 cm x 3.0 cm)

Weight (Product): 0.95 lbs (0.4 kg)

Weight (Shipping): 1.7 lbs (0.7 kg)

Compliance:

RoHS, CE, FCC Class A, CISPR 22 Class A, CISPR 24, CSA/UL
(USA & Canada), EN60950

FCC Compliance Statement

This equipment has been tested and found to comply with the limits for a Class A digital device, pursuant to Part 15 of the FCC Rules. These limits are designed to provide reasonable protection against harmful interference when the equipment is operated in a commercial environment. This equipment generates, uses, and can radiate radio frequency energy, and if it is not installed and used in accordance with the instruction manual, it may cause harmful interference to radio communications. Operation of this equipment in a residential area is likely to cause harmful interference, in which case the user will be required to correct the interference at his own expense.